

## CUT KNURLING HOLDER (for Plain cut)

**New Type**

### KH 1CN20N·25N

For NC lathe and versatile lathe

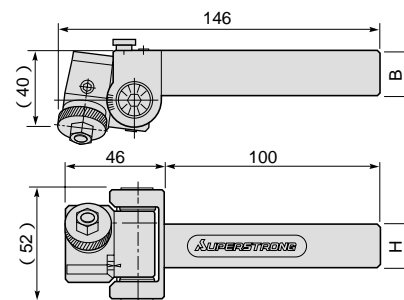

(Unit:mm)



Knurling wheel is sold separately.

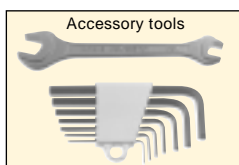

Item No.	H	B	Knurling range	Weight (g)	Applicable knurling wheel	Remarks
KH 1CN20N	20	20	3 ~ 250	710	KNC F2105R ~ F2120R	
KH 1CN25N	25	25	3 ~ 250	890		

## CUT KNURLING HOLDER (for Plain cut)

### KH 1CN20·25

For NC lathe and versatile lathe

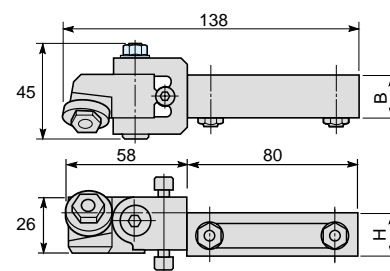

(Unit:mm)



Knurling wheel is sold separately.

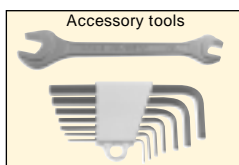

Item No.	H	B	Knurling range	Weight (g)	Applicable knurling wheel	Remarks
KH 1CN20	20	20	3 ~ 250	520	KNC F2105R ~ F2120R	
KH 1CN25	25	25	3 ~ 250	660		

## CUT KNURLING HOLDER (for Plain cut) PAT.

### KH 1CS20·25

For versatile lathe

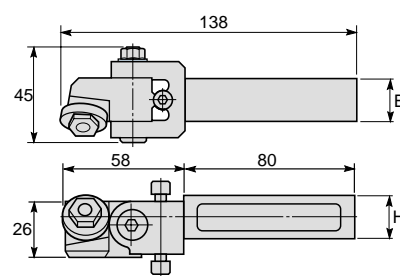

(Unit:mm)

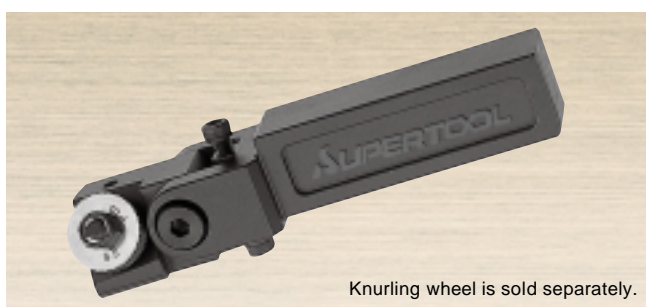

Knurling wheel is sold separately.

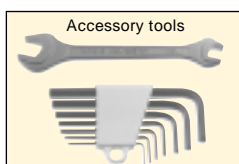

Item No.	H	B	Knurling range	Weight (g)	Applicable knurling wheel	Remarks
KH 1CS20	20	20	3 ~ 250	520	KNC F2105R ~ F2120R	
KH 1CS25	25	25	3 ~ 250	660		

KNURLING HOLDER