

SAFETY LIFTING CLAMPS



INSTRUCTION FOR OPERATION OF "SUPER" BRAND LIFTING CLAMPS

SKC



SUPERTOOL
OSAKA, JAPAN

On the Proper Handling of Lifting Clamps with Super Tool's Mark

We are thankful to you for your selection and purchase of our Lifting Clamps with Super Tool's mark on them. Our Lifting Clamps with Super Tool's mark on them (hereinafter to be called "Lifting Clamp" or "Clamp") is energy-saving lifting tools designed and developed for transportation of U-shaped reinforced and semi-thick-walled reinforced concrete gutters, U-shaped flumes, and concrete shelf boards.

Proper use of Lifting Clamps demanded

You are kindly asked to operate the Lifting Clamps after careful reading and understanding of this instruction manual for the purpose of enhancing safety and efficiency at work.

Prime efficiency and economy

The sophisticated functions, reasonableness and wide applications of the finely and carefully designed Lifting Clamps ensure prime efficiency and economy.

Special care of safety

We have executed tensile tests with loads three times (or twice) the rated capacity according to the testing standards set forth by the National Institute of Industrial Safety of Ministry of Labor and attached inspection numbers to individual products, thus directing special attention to the aspect of safety.

Attachment of products and completed operation liability insurance

If there occur damages due to the defective qualities of the Lifting Clamps under the normal conditions of use, insurance money under the products and completed operation liability insurance will be paid for them. If the damages are, however, incurred due to intentional misbehavior or mistaken use (non-safety actions), abrasion of the clamp pads, they are not covered. Be careful. Never fail to post before use the application for registration for products and completed operation liability insurance attached with the clamp (return post card) after filling in all the required items of information.

Cautions for safety operation

Please do not fail to carefully read this instruction manual before use of the Lifting Clamps.

Mistaken use of the Lifting Clamps (hereinafter to be called "Clamps") may cause troubles such as the dropping of lifted work.

Please never fail to carefully read this manual for proper operation before use.

Education of "crane safety regulations," "operation manual for lifting clamps," "in-house operation standards," etc. is to be given before actual operation not only to business owners who have purchased the Clamps but also to their operators to ensure that actual operators will have acquired enough knowledge of clamps, safety information, and cautions.

As according to the "Lifting clamp safety council," we have divided cautions in general into "Dangers" and "Cautions," which are used in this instruction manual.



DANGER:

Indicates mistaken handling may cause a potentially hazardous situation which, if not avoided, could result in death or serious injury.



CAUTION:

Indicates mistaken handling may cause a potentially hazardous situation which, if not avoided, could result in medium damage or slight injury, or could result in property damage.

Even though only mentioned in the Cautions, those incidents may lead to a serious disaster. So, do not fail to pay attention both to dangers and cautions which are of great importance in operating the Clamps properly.

● Meanings of Signs



The signs of \diamond and \triangle indicate that attention is to be given to the marks indicative of dangers and cautions respectively. The signs figuratively show the contents of danger or caution. (The left-side sign indicates a caution to the pinching.)





The sign indicates prohibited actions.









The sign of $_$ indicates that an action is enforced or instructed to be executed. Inside the sign or beside it is shown a concrete instruction is described. (The left-side sign requires a lifting at two points.)

※After reading of this manual, please keep it at a convenient place to which any user can gain easy access for reference.







1. About handling in general

 Dangers	
<ul style="list-style-type: none"> ● Any person who is not well-informed about instruction manual, tags, and signs of cautions is not eligible for use of the Lifting Clamps. ● Any person who is not legally qualified is never to operate a crane and a lifting clamp. (Clauses 221 and 222, Crane Safety Regulations) ● While lifting or turning the work, do not enter the area where the lifted work threatens to drop off or fall over. (Clauses 28 and 29, Crane Safety Regulations) ● Do not use this lifting clamp for other purposes than lifting work. 	
<ul style="list-style-type: none"> ● Never fail to execute an inspection before use and periodical inspections. (Clauses 217 and 220, Crane Safety Regulations) 	



2. About checkings before operation





 Dangers	
<ul style="list-style-type: none"> ● Do not use a clamp other than applicable to the operation method. ● Do not use an abnormal clamp with deformation, cracks, operational trouble, abrasion, etc. ● If the work to lift is under the following conditions, do not apply the clamp. (fragile material, high-hardness material, low-hardness or extremely low-hardness material, and members with the gripping part of no pitchedness and of more than 10 degrees in temperature of itself) 	
<ul style="list-style-type: none"> ● Please check on the clamp main unit the type, basically applicable load, opening diameter, and indication of periodical inspections executed. ● The load of the work to lift shall be within the allowable range of the basically applicable load of the clamp. ● The thickness of the work to lift shall be within the allowable clamping range. 	
 Cautions	
<ul style="list-style-type: none"> ● Do not use the clamp for the work under the following conditions. (The work to lift is more than 150 degrees, is less than minus 20 degrees in temperature, and acidic or alkaline chemicals.) 	
<ul style="list-style-type: none"> ● The sling to be used for the clamp shall be an appropriate one for the lifting operation. 	

3. About the method of use and lifting operation





 Dangers	
<ul style="list-style-type: none"> ● Do not use the Clamp, lifting at one point. ● Do not use the Clamp in the following way of lifting: (overlapped works, padded work, engrafted lifting, concurrent lifting, and side gripping) ● Do not use the Clamp for pulling out from among steel sheet pilings and not lift pulled-out steel sheets vertically. ● Do not use the Clamp when strong wind threatens to cause any danger. ● Do not use the Clamp for a hydraulic excavator. 	
<ul style="list-style-type: none"> ● Install two or more Clamps in a balanced way to keep the work¹ balance. 	
<ul style="list-style-type: none"> ● The lifting angle of the Clamp and the dividing angle are to be kept within the allowable angles according to types. ● The work is to be inserted to the innermost end of the Clamp opening. ● When you use the Clamp with a locking system, never fail to use the Clamp with the locking system on. 	
 Cautions	
<ul style="list-style-type: none"> ● If oil, paint, scales, rust, etc. are on the gripping pad, do not use the Clamp. ● Do not drop to the ground or drag along the ground the Clamp. 	

4. About the operation of a crane

 Dangers	
<ul style="list-style-type: none"> ● Never lift the work weighing more than the basic working load. ● Do not operate the crane in such a way as to give an impacting load to the work or the Clamp. ● Do not allow a man to stand on the lifted work. Never use the Clamp for the purpose of carrying a man. ● Do not lift the earth itself. ● In the course of lifting the work, do not release the lock of the Clamp. ● Do not let the Clamp removed from the work collide with the work or an adjacent member. 	

<ul style="list-style-type: none"> ● When you wind up the wire by the crane and notice the load at the lifting ring, stop the operation temporarily for safety checking (depth of the work into the Clamp opening; status of locking). ● Stop the operation of the crane just before the work reaches the ground, check the following items of things: (Slant and falling over of the work; security at the landing site and its surrounding) 	
 <h2 style="margin: 0;">Cautions</h2>	
<ul style="list-style-type: none"> ● Do not operate the crane in such a way as to drag the work along the ground. ● Do not step away from the crane (winder, etc.) operating position while keeping the work being lifted with the Clamp. 	
<ul style="list-style-type: none"> ● Hoisting and lowering operation by the crane are to be made slowly and carefully. 	

5. About maintenance, storage and remodeling

 <h2 style="margin: 0;">Dangers</h2>	
<ul style="list-style-type: none"> ● Never execute any remodeling of the Clamp and its accessories. ● Do not apply welding work or heating to the Clamp and its accessories. ● Do not use any other parts than our company's brand-name parts. ● Store at a different place Clamps requiring repairing not to be used mistakenly. 	
<ul style="list-style-type: none"> ● A person with specialized knowledge specified by the business owner is to conduct maintenance and repairing work. ● When you detect abnormality with the Clamp, do not use it and immediately repair or dispose of it. ● Remove, if any, paint or mud sticking to the moving parts of the Clamp, cams, and pads. 	
 <h2 style="margin: 0;">Cautions</h2>	
<ul style="list-style-type: none"> ● Conduct maintenance and repairing with no work lifted. ● Conduct maintenance and repairing after posting a sign indicating that you're working on the maintenance work. ● Never fail to put lubricating oil on the rotating part of the Clamp (around the pin), guide groove, sliding parts, etc. ● Store Clamps inside a room. 	

Note: Please contact our company's sales agents or sales offices to make advantage of our services in respect with items of inspections and maintenance standards accompanying disassembly and assembly.

U-Shaped Gutter Lifting Clamp SKC Operation Manual

■ Applications

This is a dedicated clamp optimal for lifting and carrying products such as precast reinforced-concrete U-shaped gutter.

■ Features

1. Fastening strength increases in proportion to lifting load, enabling fast clamping.
2. The spring always applies a certain amount of initial load to the clamp, so the clamp continues to hold the work, even if the work has reached the ground and the wire has been loosened.
3. The clamp is equipped with a release-lock mechanism, so it is easy to attach and detach the clamp to and from concrete products.
4. The major components are of die-forged special-alloy steel and applied appropriate heat treatment, so the unit is light-weighted and highly durable.

■ Specifications

Product No.	Type	Capacity (kg)	Clamping range (mm)	Product weight (kg)
SKC150	Hand type	150	30~60	3.0
SKC150M	Machine type	150	30~60	3.0
SKC250		250	50~80	3.0
SKC250W		250	70~100	3.5
SKC1250D		1250	73~137	10.0

Part names (SKC150; SKC150M; SKC250; SKC250W)

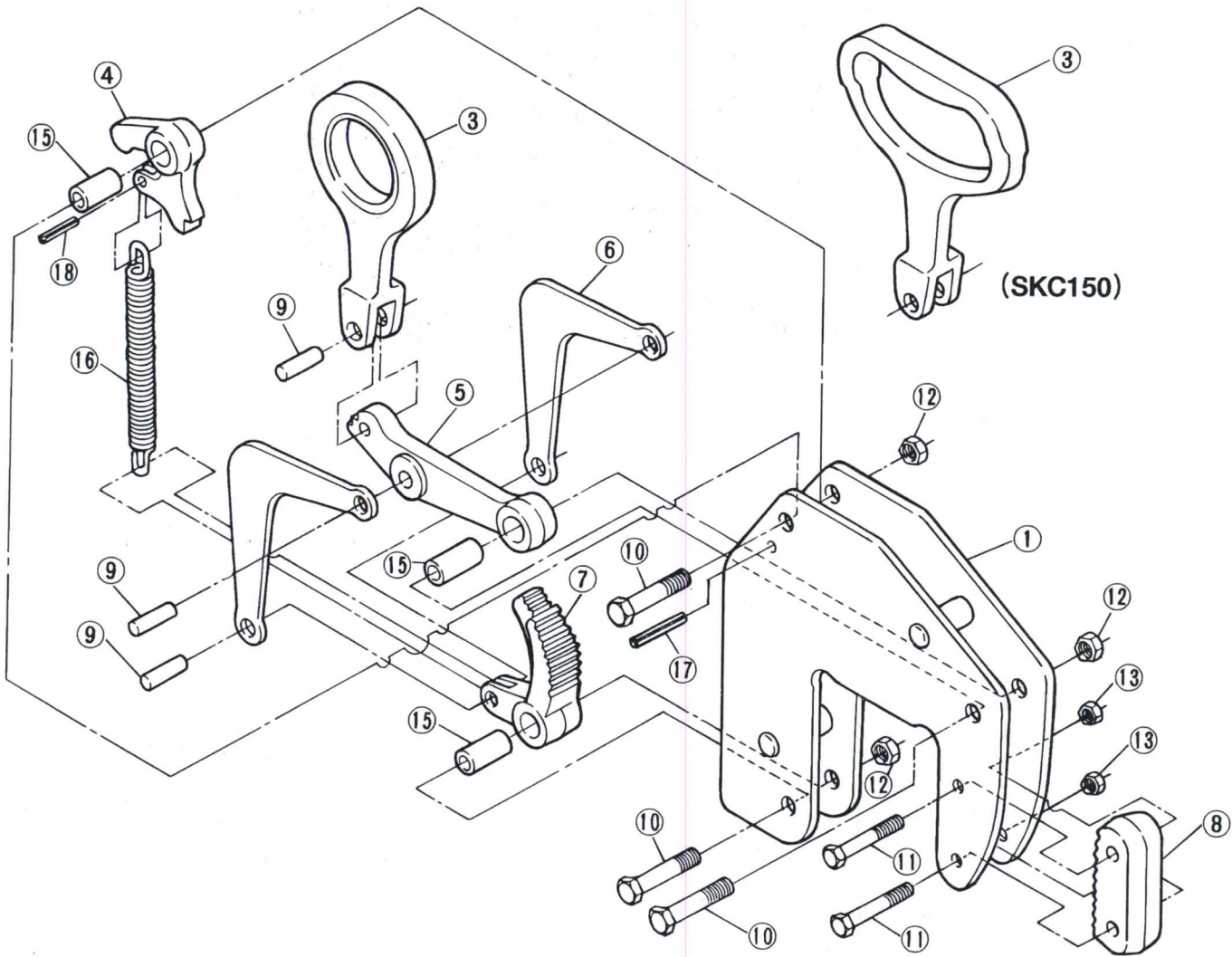

Part No.	Part name	Part ref. code	Quantity	Part No.	Part name	Part ref. code	Quantity
Shackle				Link			
3	Shackle	SKCH	1	6	Link	SKCL	2
9	Connecting pin	SKCX	1	9	Connecting pin	SKCX	1
Lever				Cam			
4	Lever	SKCF	1	7	Cam	SKCT	1
10	Hexagon bolt (large)	SKCN	1	10	Hexagon bolt (large)	SKCN	1
12	Hexagon nut (large)		1	12	Hexagon nut (large)		1
15	Collar	SKCY	1	15	Collar	SKCY	1
17	Spring pin (large)	SKCQ	1	Pad			
Arm				8	Pad	SKCP	1
5	Arm	SKCI	1	11	Hexagon bolt (small)	SKCV	2
9	Connecting pin	SKCX	1	13	Connecting pin		2
10	Hexagon bolt (large)	SKCN	1	Spring			
12	Hexagon nut (large)	SKCY	1	16	Spring	SKCS	1
15	Collar		1	18	Spring pin (small)	SKCR	1

Note 1) When you place an order for parts, attach nominal capacity value or nominal capacity plus "M" / "W" just after Part ref. code.

(Ex. Cam for SKC150 is to be SKCT150.)

(Ex. Pad set for SKC250W is to be SKP250W.)

2) Periodically apply lubricating oil to the rotation parts of each component.

Part names (SKC1250D)

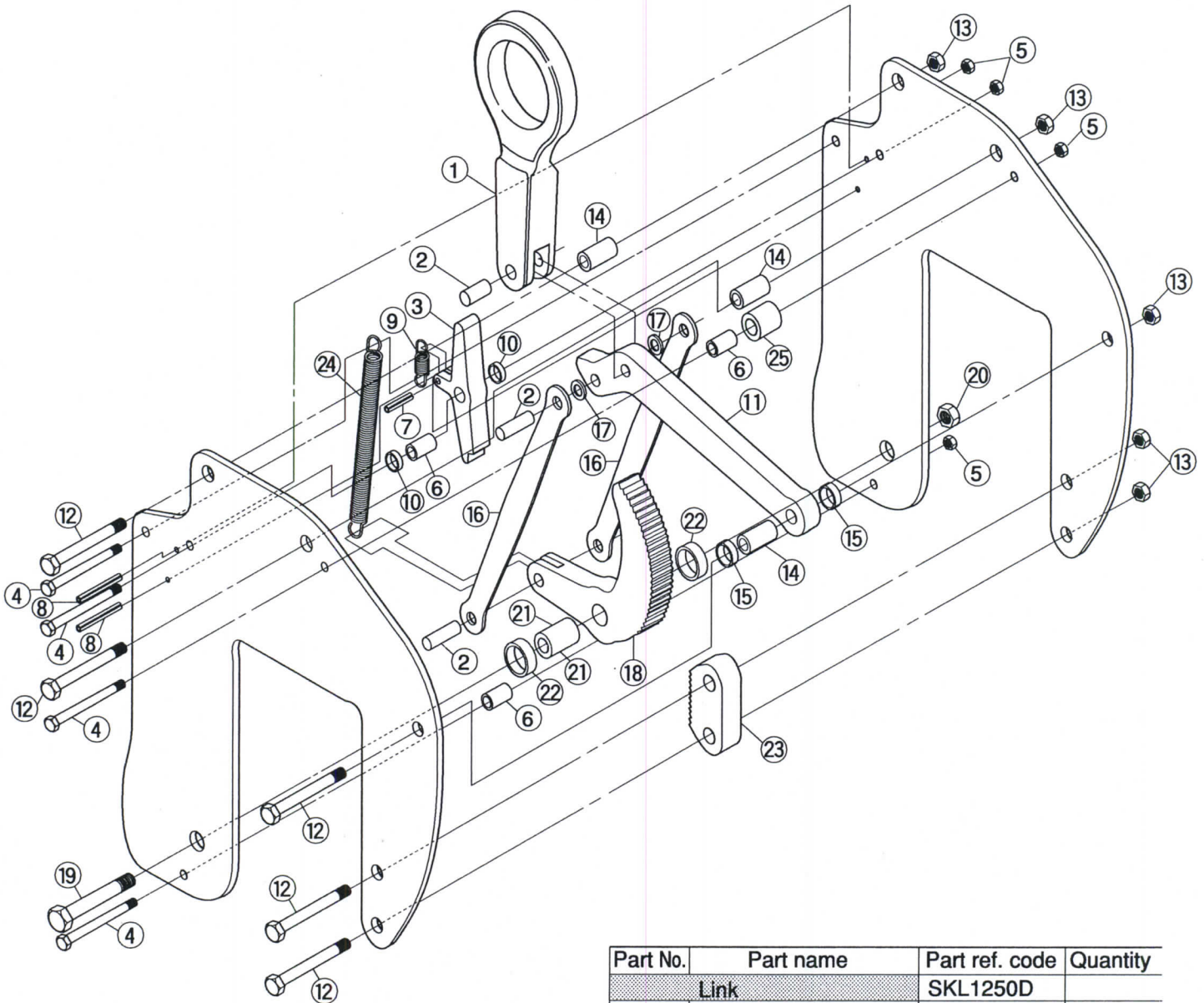

Part No.	Part name	Part ref. code	Quantity
Shackle			
1	Shackle	SKH1250D	1
2	Connecting pin	SKCX1250D	1
Lever			
3	Lever	SKCF1250D	1
4	Hexagon bolt (small)	SKCN1250D	1
5	Hexagon nut (small)		1
6	Collar (small)	SKCY1250D	1
7	Spring pin (short)	SKCQ1250D	1
8	Spring pin (long)		2
9	Spring for lever	SKCB1250D	1
10	Spacer (small)	SKCA1250D	2
Arm			
11	Arm	SKCI1250D	1
2	Connecting pin	SKCX1250D	1
12	Hexagon bolt (middle)	SKCV1250D	1
13	Hexagon nut (middle)		1
14	Collar (middle)	SKCW1250D	1
15	Spacer (middle)	SKCC1250D	2

Part No.	Part name	Part ref. code	Quantity
Link			
16	Link	SKL1250D	2
2	Connecting pin	SKCX1250D	1
17	Flat washer	SKCZ1250D	2
Cam			
18	Cam	SKCT1250D	1
19	Hexagon bolt (large)	SKCK1250D	1
20	Hexagon nut (large)		1
21	Collar (large)	SKCM1250D	1
22	Spacer (large)	SKCD1250D	2
Pad			
23	Pad	SKCP1250D	1
12	Hexagon bolt (middle)	SKCG1250D	2
13	Hexagon nut (middle)		2
Spring for Cam			
24	Spring for Cam	SKCS1250D	1
4	Hexagon bolt (small)	SKCN1250D	1
5	Hexagon nut (small)		1
Stopper			
25	Stopper	SKCE1250D	1
4	Hexagon bolt (small)	SKCN1250D	1
5	Hexagon nut (small)		1
6	Collar (small)	SKCY1250D	1

Note) Periodically apply lubricating oil to the rotation parts of each component.

About operation

1. Operational method

- ① Lower the shackle in the direction as indicated by the arrow till it gives a "clicking sound".
The cam retreats into the main body and is stopped inside, securely retaining an open-mouth status. (Fig. 1)
- ② Lower the clamp downward till the upper edge of the side wall of the U-shaped gutter reaches the innermost end of the open mouth. And push the lever toward the shackle so that the open-mouth holding lock is unlocked and the cam protrudes to clamp the work. (Fig. 2)
- ③ To remove the clamp, lock the open-mouth holding lock as shown in Item ① before removing the clamp.

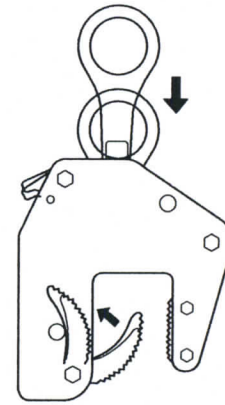

(Fig.1)

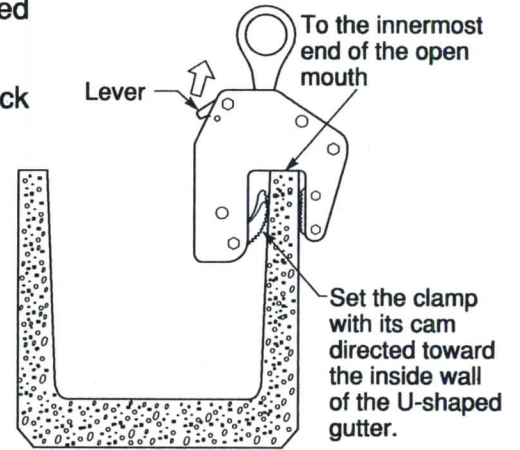

(Fig.2)

2. Lifting-operation method

- ① When you lift the U-shaped gutter, the cam is to be set so that it is directed toward the inside wall of the gutter, and lift it at two points or more. Refer to (Table 1) for the major dimensions of U-shaped gutters intended for lifting. And the lifting angle is to be within the range indicated in (Fig. 3), and attach them considering the balance. Use a single wire for each clamp. Use the wire of the same length for them.

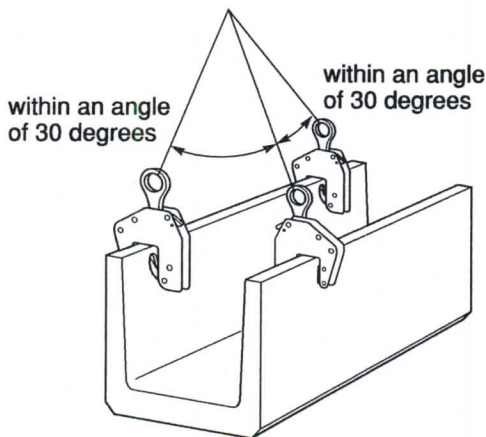

(Fig.3)

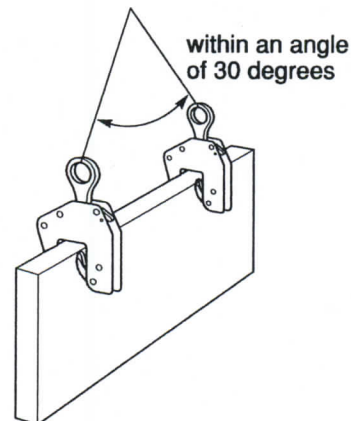
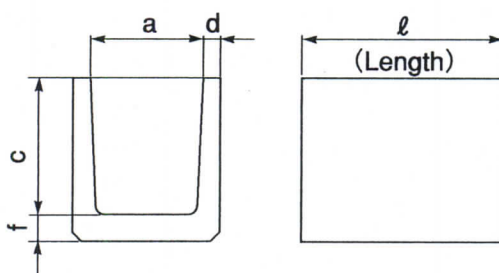
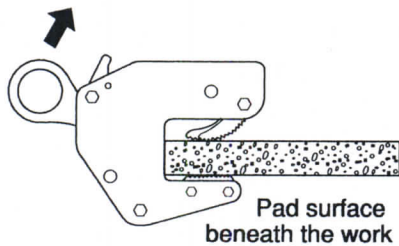

Table 1

Shapes of U-shaped gutters	Nominal	a	c	d	f	ℓ	Weight (kg)
		150	150	150	30	35	600
	180	180	180	35	40	600	33.8
	240	240	240	45	50	600	55.9
	300A	300	240	50	60	600	71.0
	300B	300	300	50	60	600	80.4
	300C	300	360	50	65	600	92.6
	360A	360	300	50	65	600	90.6
	360B	360	360	50	65	600	100.8



- ② When you raise the work, clamp the work with the pad surface placed underneath the work. (Fig. 4)
The allowable raising and lifting angle shall be within the range indicated in (Fig. 5), and inversion is not allowed.



(Fig.4)

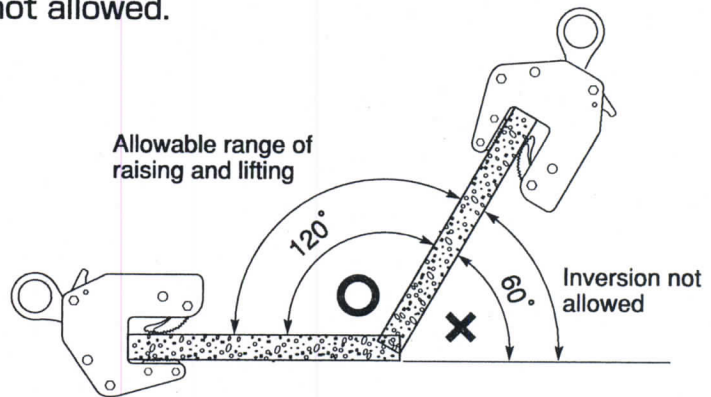

(Fig.5)

3.Method of assembling/disassembling parts

(1) Disassembly

(i) Pad

Loosen the bolts and nuts which fix the pad to the main body with a wrench and remove the pad.

(ii) Cam and others

Loosen the bolts and nuts which fix the arm, cam, and spring to the main body with a wrench and remove the shackle, arm, link, cam, and spring from the main body. (In case of SKC1250D, take out the spring pin which fastens the spring for cam from the main body with a pin punch.) Removed parts can be disassembled after taking out the connecting pin.

(iii) Lever

Loosen the bolts and nuts which fix the lever to the main body with a wrench and remove it from the main body. (In case of SKC1250D, take out the spring pin which fastens the spring for cam from the main body with a pin punch.)

(2) Assembly

Follow the reversed procedure of disassembly

Cautions for safety

- ◆ Use this unit within the allowable load.
- ◆ Apply this Unit only to boards of the allowable thicknesses (within the set clamping ranges).
- ◆ Do not apply this Unit to any other products than concrete ones.
- ◆ Do not give any impact to the work or the lifting clamp.
- ◆ Do not lift layers of concrete products at one time.
- ◆ Never fail to check before use for plugging of the gripping surface of the cam and the pad, their abrasion statuses, and abnormalities with any other parts.
- ◆ Do not remodel the unit. Application of any heat or modification may cause a substantial degrading of the quality (strength) of the unit.
- ◆ Do not apply this unit to concrete products under curing.
- ◆ Do not use this unit for lifting up or extracting concrete products buried underground.
- ◆ When water, oil, sands, etc. is on the surface of the cam, the pad, or concrete products (works), there threatens to be a slipping accident. Never fail to remove any of them from the work.
- ◆ The work to be lifted is to be inserted to the innermost end of the open mouth of the clamp.
- ◆ Do not attach clamps at both ends of the single wire, or do not apply concentrated loads to a single wire.
- ◆ Do not grip the work horizontally and lift it upward. And never lift the work in such a way that the cam or the pad grips the side wall of the U-shaped gutter one-sidedly such as clamping the tapered part.

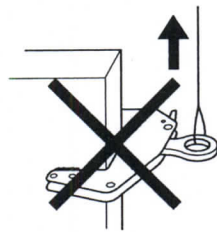

(Fig.6)

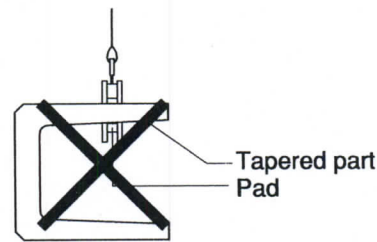

Others

1. Inquiry about maintenance supplies and repairing

If you need maintenance supplies or repairing, stop using the clamp and notify any one of the branches or sales offices of Super Tool Co. Ltd.

2. About products and completed operation liability insurance

If there occurs any damage due to the defective qualities of the products under the normal conditions of use, insurance money will be paid for the damage. (However, the compensation is not more than the amount covered.)

This insurance does not apply to the following cases:



- (1) When you have lifted objects beyond the rated capacity
- (2) When the user has been mistaken in handling the clamps or remodeled the clamps on your own judgment. Post before use the application form for registration for products and completed operation liability insurance attached with the clamp (return post card) after filling in all the required items of information.

Daily inspection

Daily inspection and maintenance is required for safety and prevention of the degradation of efficiency in operation.

1. Checking for damages such as flaws and cracks on the respective parts of the pads and the shackle.
2. Checking of whether each part is properly actuated and lubricated.
3. **Checking for abrasion, chipping, and plugging of the dens, of the cam.**
4. Refer to the maintenance standards for other details.

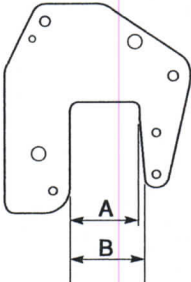
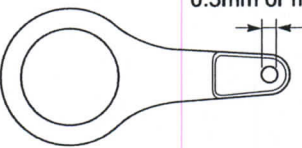
Maintenance standards

Items	Inspection method	Limit of use	Major causes of defects	Counter-measures
<p>Main body</p>	<ul style="list-style-type: none"> ● Check for flaws or cracks. (by visual check or color check) ● Check for the expanded distance of the mouth. (by measuring device) ● Check for deformation or clattering of each part. (by visual check or measuring device) 	<ul style="list-style-type: none"> ● When confirmed by visual check ● The difference between the distances of A and B is more than 5 mm or more per a depth of 100 mm (5%).  <ul style="list-style-type: none"> ● When confirmed by visual check 	<ul style="list-style-type: none"> ● Overloading ● Sudden impact load ● Overloading ● Sudden impact load ● Unreasonable lifting angle ● Overloading ● Unreasonable lifting angle 	<p>Disposition</p>
<p>Shackle</p>	<ul style="list-style-type: none"> ● Check for flaws or cracks. (by visual check or color check) ● Check for deformation of the hole. (by visual check or measuring device) ● Check for deflection. (by visual check or measuring device) 	<ul style="list-style-type: none"> ● When confirmed by visual check. ● When the shackle hole has become larger by 0.5 mm or more.  <ul style="list-style-type: none"> ● When the shackle is permanently deflected by 5 degrees or more, or clattered. 	<ul style="list-style-type: none"> ● Overloading ● Sudden impact load ● Overloading ● Natural abrasion ● Lack of lubrication ● Overloading ● Sudden impact load ● Unreasonable lifting angle 	<p>Replacement</p>

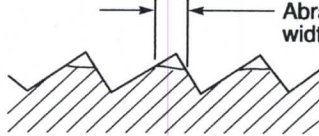
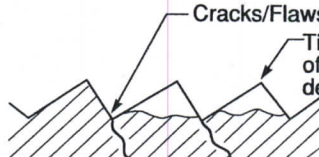
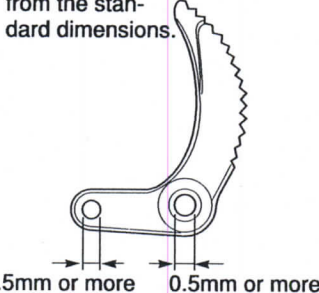
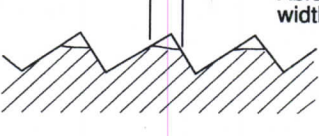
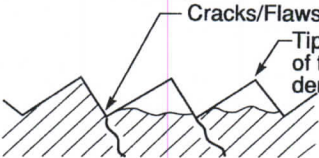
Items	Inspection method	Limit of use	Major causes of defects	Counter-measures
Cam	<ul style="list-style-type: none"> ● Check for abrasion of the dens. (by visual check or measuring device) 	<ul style="list-style-type: none"> ● When the abrasion width is 0.5mm or more 	<ul style="list-style-type: none"> ● Natural abrasion ● Clamping of hard material 	Replacement
	<ul style="list-style-type: none"> ● Check for tipping of the dens or cracks in the dens bottom. (by visual check or color check) 	<ul style="list-style-type: none"> ● When confirmed by visual check. 	<ul style="list-style-type: none"> ● Overloading ● Sudden impact load ● Clamping of hard material 	
	<ul style="list-style-type: none"> ● Check for abrasion or deformation of bolt holes. (by measuring device) 	<ul style="list-style-type: none"> ● When deformed by 0.5mm or more from the standard dimensions. 	<ul style="list-style-type: none"> ● Overloading ● Unreasonable lifting angle ● Natural abrasion ● Lack of lubrication 	
Pads	<ul style="list-style-type: none"> ● Check for abrasion of the dens. (by visual check or measuring device) 	<ul style="list-style-type: none"> ● When the abrasion width is 0.5mm or more 	<ul style="list-style-type: none"> ● Natural abrasion ● Clamping of hard material 	Replacement
	<ul style="list-style-type: none"> ● Check for tipping of the dens or cracks in the dens bottom. (by visual check or color check) 	<ul style="list-style-type: none"> ● When confirmed by visual check. 	<ul style="list-style-type: none"> ● Overloading ● Sudden impact load ● Clamping of hard material 	
Links	<ul style="list-style-type: none"> ● Check for deflection or deformation (by visual check or measuring device) 	<ul style="list-style-type: none"> ● When abnormal sound is heard or it is get stuck. 	<ul style="list-style-type: none"> ● Overloading ● Unreasonable lifting angle 	Replacement
	<ul style="list-style-type: none"> ● Check for abrasion or deformation of the pin hole (by measuring device) 	<ul style="list-style-type: none"> ● When deformed by 0.5mm or more from the standard dimensions 	<ul style="list-style-type: none"> ● Natural abrasion ● Lack of lubrication ● Overloading 	
Lever arm	<ul style="list-style-type: none"> ● Check for abrasion or deformation of the pin hole (by measuring device) 	<ul style="list-style-type: none"> ● When deformed by 0.5mm or more from the standard dimensions 	<ul style="list-style-type: none"> ● Natural abrasion ● Lack of lubrication ● Overloading 	Replacement
	<ul style="list-style-type: none"> ● Check for abrasion or deformation of the claw end (by measuring device) 	<ul style="list-style-type: none"> ● When the claw end is abraded or deformed, so release status can not be locked. 	<ul style="list-style-type: none"> ● Natural abrasion 	

Items	Inspection method	Limit of use	Major causes of defects	Counter-measures
Hexagonal bolts and nuts	<ul style="list-style-type: none"> ● Check for abrasion of the shaft (by measuring device) ● Check for flaws or cracks (by visual check or color check) ● Check for deflection or deformation. (by visual check or measuring device) 	<ul style="list-style-type: none"> ● When they have become smaller by 0.5mm or more from the standard dimensions. ● When confirmed by visual check ● When deformed by 0.5mm or more from the standard dimensions. 	<ul style="list-style-type: none"> ● Natural abrasion ● Lack of lubrication and others ● Overloading ● Sudden impact load ● Unreasonable lifting angle ● Overloading ● Sudden impact load ● Unreasonable lifting angle 	Replacement
Connecting pin	<ul style="list-style-type: none"> ● Check for abrasion the shaft. (by measuring device) ● Check for deflection or deformation. (by visual check or measuring device) 	<ul style="list-style-type: none"> ● When it has been reduced by 0.5mm or more from the standard dimensions. ● When deflected or deformed by 0.5mm or more. 	<ul style="list-style-type: none"> ● Natural abrasion ● Lack of lubrication and others ● Overloading ● Sudden impact load ● Unreasonable lifting angle 	Replacement
Spring for Cam	<ul style="list-style-type: none"> ● Check whether there is proper rebounding, when the cam is pressed inward for the widest mouth. ● Check whether they are closely contact with each other when the spring is under free status. (by measuring device) 	<ul style="list-style-type: none"> ● When proper rebounding is not confirmed and the movement of the cam is not smooth. ● When the spring is extended by 5% or more from the original length. 	<ul style="list-style-type: none"> ● Repetition fatigue ● Repetition fatigue 	Replacement
Spring for Lever	<ul style="list-style-type: none"> ● Check whether there is proper rebounding in the release-locked status. ● Check whether they are closely contact with each other when the spring is under free status. (by measuring device) 	<ul style="list-style-type: none"> ● When proper rebounding is not confirmed and the movement of the cam is not smooth. ● When the spring is extended by 5% or more from the original length. 	<ul style="list-style-type: none"> ● Repetition fatigue ● Repetition fatigue 	Replacement

Items	Inspection method	Limit of use	Major causes of defects	Counter-measures
Cam supporting bolt	<ul style="list-style-type: none"> ● Check for abrasion of the shaft. (by measuring device) ● Check for flaws or cracks. (by visual check or color check) ● Check for deflection or deformation. (visual check or measuring device) 	<ul style="list-style-type: none"> ● When it has been reduced by 0.5mm or more from the standard dimensions. ● When confirmed by visual check ● When deflected or deformed by 0.5mm or more. 	<ul style="list-style-type: none"> ● Natural abrasion ● Lack of lubrication and others ● Overloading ● Sudden impact load ● Unreasonable lifting angle ● Overloading ● Natural abrasion ● Sudden impact load 	Replacement
Spring	<ul style="list-style-type: none"> ● Check whether a certain amount of initial load is always working when the cam is closed. ● Check whether there is proper rebounding, when the cam is pressed inward for the widest mouth. 	<ul style="list-style-type: none"> ● When proper rebounding is not obtained due to deformation, etc. and the movement of the cam is not smooth. ● When proper rebounding is not obtained due to deformation, etc. and the movement of the cam is not smooth. 	<ul style="list-style-type: none"> ● Repetition fatigue ● Repetition fatigue 	Replacement