

# SAFETY LIFTING CLAMPS



INSTRUCTION FOR OPERATION

“SUPER” BRAND  
LIFTING CLAMPS

**DLC**

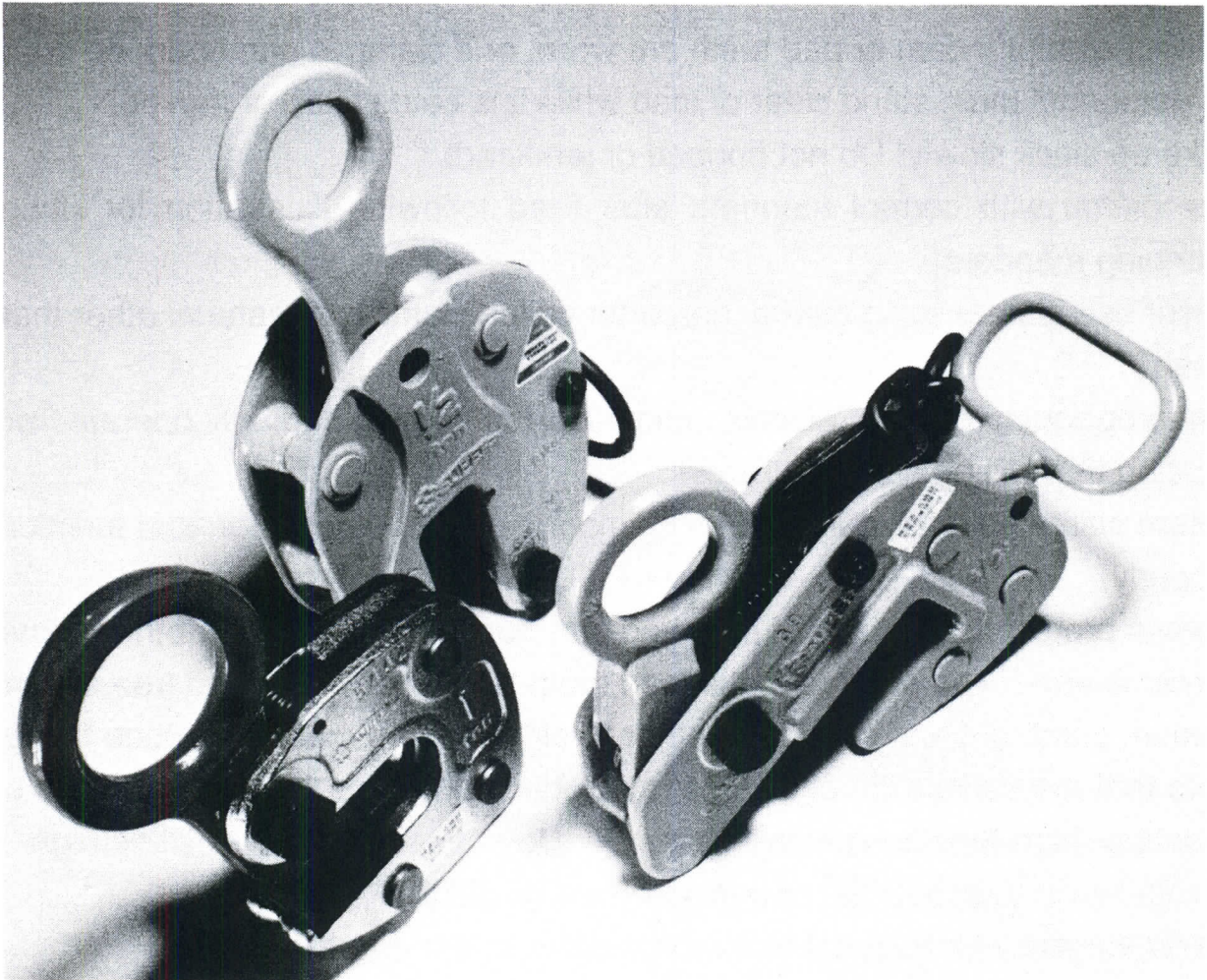

**SUPERTOOL**

OSAKA, JAPAN

# INSTRUCTIONS FOR USE

Keep these instructions within easy access of operators.

It is important that operators understand these warnings and instructions before using.

## WARNINGS

- Select proper size clamp for the job! Determine the weight of the plate, H-beam or steel structure to be lifted!  
Do not exceed limited working load shown on clamp!  
Plate thickness must be within grip range shown on clamp. In some cases with hardened plates, light plates (less than 1/5 of capacity marked on the clamp) and thin plates (less than 1/4 of the maximum clamping range), the clamping force of the clamp will be reduced. In these cases, confirm that the clamp has positive grip before lifting!
- Inspect clamp! If cam or pad teeth are worn, or if clamp is damaged, do not use!
- All personnel must stand clear of load while it is being lifted or moved!
- Take up slack slowly! Do not bounce or jerk load!
- Use clamp with correct manners after read following illustration for lifting and clamping manners!
- Never use a steel lifting clamp (hereafter called clamp) on material other than steel!
- When operating clamps, always maintain a firm footing and only operate from a location that will be safe at all times!
- Before lifting the load, confirm that clamps are in good condition and functioning properly!
- Always protect the surface of cam and pad from weld spatters or other damaging contaminants! The surface of the load must always be clean and free of scale, grease, paint, dirt and coating or other foreign matters that can reduce friction!
- Note that the service life of clamps is reduced considerably when stainless steel sheets or high-tensile steel are clamped! Do not use clamps for lifting high-tensile steel (over 300HB) or soft steel (under 80HB) !
- Never vertically lift material that tapers down to the edge!
- Never vertically lift with horizontal or lateral clamps!
- Never lift more than one steel plate at a time!
- Always use slings correctly! Pay special attention to the correlation between the lifting angle and the rated load!

- Never operate clamps unless the load is properly centered!
- After the load has been lifted a few centimeters, confirm that the load is well balanced!
- Never allow the operator's attention to be diverted when operating clamps and never leave the suspended load unattended!
- Never modify clamps!
- Only use genuine parts when repairing clamps!
- Please refer, also, to the warnings in the catalog.

## CORRECT MANNER OF USE

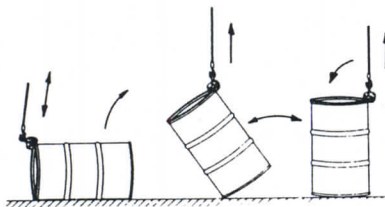

Setting up, setting down



One point lifting



Lifting four drums with four clamps (in this case, the drums are lifted vertically.)



Using two clamps (This is safe when lifting a heavy drum, containing, for example, iron powder.)

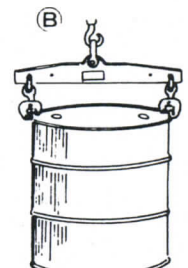

Vertical lifting is possible when DLC is combined with the balance for drum lift clamp.

## ✘ BE CAUTIOUS... DANGEROUS.

1. Do not lift other objects than drums.
2. When a drum is filled with iron powder, it weights about a ton. In this case, lift with two clamps as shown above. Or, reduce the content.

3. This clamp cannot lift a drum without brim.



When lifting a drum of which brim is deformed or repaired. check the chucking state when gripping.

# LIFTING ANGLE AND SAFE LOAD OF WIRE ROPE

The maximum allowable load (safe load) of wire rope also varies with the lifting angle. Therefore, select a wire rope of proper diameter in consideration of the lifting angle. (The breakage load specified in table below refers to No.4. 6×24A class of JIS G3525.)

## Correlation between Lifting Angle and Safe Load of Wire Rope (in two-point lifting)

D Wire rope dia (mm)	σ Break-age load (tons)	W Safe load (on one rope) $W = \sigma / S$ (safety factor S=6) (tons)						
			(Changes in lifting efficiency due to lifting angle.%)					
			100%	96%	92%	86%	70%	50%
			Max.allowable load (safe load) on two wire ropes (tons)					
8	3.21	0.54	1.08	1.04	0.99	0.93	0.76	0.54
9	4.06	0.68	1.36	1.31	1.25	1.17	0.95	0.68
10	5.02	0.84	1.68	1.61	1.55	1.44	1.18	0.84
11.2	6.29	1.05	2.1	2.02	1.93	1.81	1.47	1.05
12.5	7.84	1.31	2.62	2.52	2.41	2.25	1.83	1.31
14	9.83	1.64	3.28	3.15	3.02	2.82	2.3	1.64
16	12.8	2.13	4.26	4.09	3.92	3.66	2.98	2.13
18	16.2	2.7	5.4	5.18	4.97	4.64	3.78	2.7
20	20.1	3.35	6.7	6.43	6.16	5.76	4.69	3.35
22.4	25.2	4.2	8.4	8.06	7.73	7.22	5.88	4.2
25	31.3	5.22	10.44	10.02	9.6	8.98	7.31	5.22
28	39.3	6.55	13.1	12.58	12.05	11.27	9.17	6.55
30	45.1	7.52	15.04	14.44	13.84	12.93	10.53	7.52
31.5	49.8	8.3	16.6	15.94	15.27	14.28	11.62	8.3
33.5	56.3	9.38	18.76	18.01	17.26	16.13	13.13	9.38
35.5	63.2	10.53	21.06	20.22	19.38	18.11	14.74	10.53

Note For four-point lifting, multiply the corresponding figure in the table by 2 to find the maximum allowable load (safe load).

## Simplified calculation method of wire rope diameter and safe load(one-point lifting)

1)  $D = \sqrt{W \times C}$

2)  $W = \frac{D^2}{C}$

Where D : wire rope diameter(mm)  
W : safe load(tons)  
C : constant=120  
(safety factor S=6)

★To find the diameter of wire rope for 3 tons :

①  $D = \sqrt{W \times C}$

$D = \sqrt{3 \times 120} = \sqrt{360} = 19 \rightarrow 20\text{mm}$

★To find the service load (safe load) on 25mm diameter wire rope.

②  $W = \frac{D^2}{C}$

$W = \frac{25^2}{120} = \frac{625}{120} = 5.2 \rightarrow 5.2\text{ton}$

# "SUPER" CLAMPS Maintenance and Repair

Check periodically, repair and replace parts, and use correctly in order to use the clamps over the full service life, safely.

## Common Check Points

- ★ Check the main body for distortion or flaw.
- ★ Make sure the opening is normal (check if widened).
- ★ Check if the shackle is distorted.
- ★ Check the shackle pin hole for widening or looseness.
- ★ Check cam and pad teeth for defect or wear.
- ★ Check cam pin hole in main body for widening.
- ★ Check if cam pin is worn and thinned.
- ★ Check the performance of tightening lock (handle, lever), shackle, and other mechanism.

Check all the listed items. Inspect according to the Checking Standard.

Most items may be checked visually or by touching. To measure the safety point distance and opening size, use slide calipers or the like to obtain precise measurements.

### DISCARD

When clearance between bolt and hole exceeds 1 mm, and deflection of cam or shackle becomes excessive.

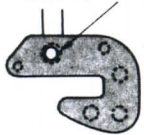

(Wear of pin or shackle hole)



(Flaw of main body)

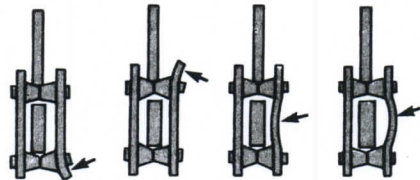

(Distortion of main body)

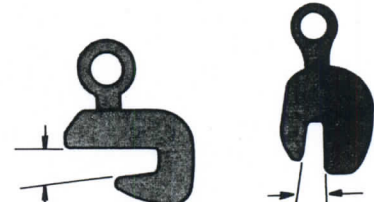

(Widening of opening)

Discard the clamp if obvious flaw or distortion is found in the main body. Defects in the main body cannot be repaired in the light of safety. The main body may be cracked or deformed only after several uses if it is used incorrectly. Dent or swelling of main body, or widening of opening may be caused by overload or wrong manner of use. If the defect is repaired by welding, hardening, or pressing, the original strength is not recovered. When used and controlled correctly, the clamp may be safely used for a long time only by replacing parts.

### REPLACE

(Shackle)

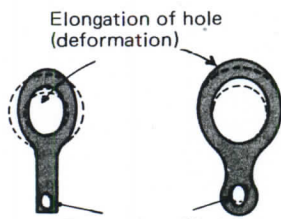

Elongation of hole (deformation)

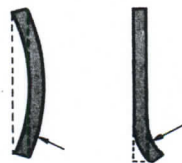

Distortion (deformation)

(Cam and pad)



Clamping capacity	Wear limit width of cam, pad
0.5 ton	0.5mm or more
1 ton	
2 ton	
3 ton	
5 ton	

Regard the shackle as part of body. If deformed as shown above, replace it immediately. If deformed shackle is straightening up, the initial strength is not restored.

When worn as shown above, replace immediately. Or, if not worn, when even one tooth is missing, replace also immediately. The wear rate is accelerated when stainless steel or other hard material is clamped. Or when plates of specified thickness are continuously clamped, only particular threads will be worn in a short time. In such a case, too, replace immediately.

Besides, replace the support pins, bolts, springs, and other parts according to the Checking Standard.

## Check Twice to Confirm Safety.

Check the type capacity of clamp. Is the wire rope proper? How about its size and length? Overloaded or not? Where's the center of gravity? Is the material inserted fully? Is it locked securely? Lift at two points for an object longer than a meter. Lift at three or four points where the center of gravity is hard to locate. Is the lifting angle proper? Check all these items, and confirm them once again. Lift, carry, touch down slowly. Be careful not to hit against surrounding objects while carrying. Keep off hands. Do not enter hazardous zone. Always pay attention to safety.

# Drum Lift Clamps

**Model : DLC**

## Operation method

### 1. Direction to set a clamp

As shown figure 1, the pad should be toward the inside of brim of drum and the cam should be toward the outside of brim of drum.

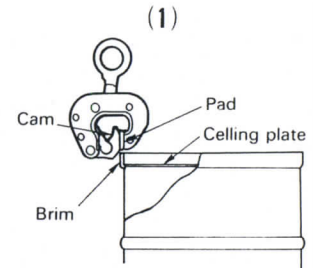

### 2. Chucking

Press the lower side of cam to the brim of drum until the body touches on the ceiling plate of drum. Then the clamp catches the drum instantly. (Figure 2)

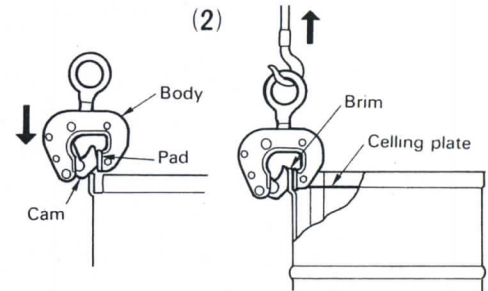

### 3. Releasing

After loosened a wire rope, push down (toward the direction of cam) the shackle of clamp.

Then the clamp is opened to release the clamp. (Figure 3)  
When it is hard to push, hit the shackle by hand slightly.

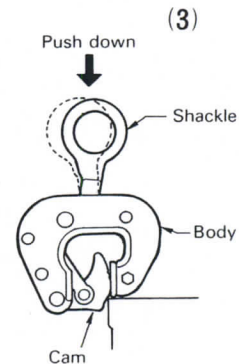

## DRUM LIFT CLAMPS

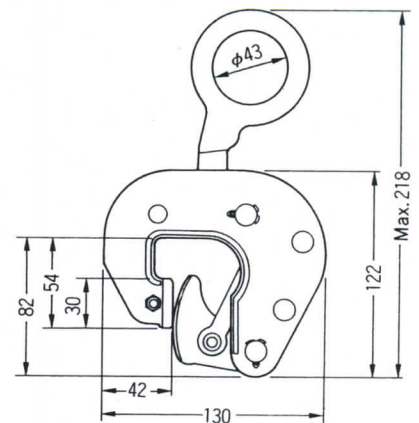
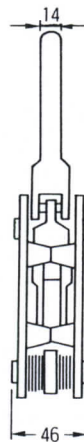
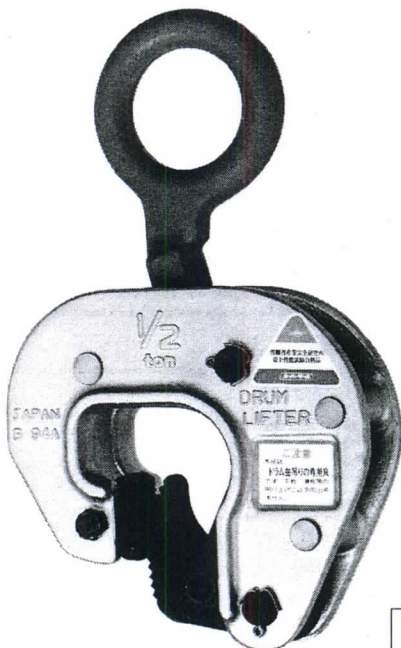

Unit : mm

ITEM NO.	Capacity (tons)	b	B	D	t	T	H	L	Weight (kg)
DLC 0.5	0.5	18	130	41	14	46	122	218	2

# Replacement parts and fittings

Part No.	Part Name	Item No.
<b>SHACKLE ASSEMBLY</b>		<b>DLH</b>
2	Shackle	DLCH
4	Support pin for Shackle	DLCY
<b>PAD ASSEMBLY</b>		<b>DLP</b>
3	Pad	DLCP
9	Bolt for Pad	DLCN
10	Bolt for Nut	
8	Cam · Rod	DLT
<b>LINK ASSEMBLY</b>		<b>DLL</b>
5	L shaped link	DLCL
6	Connecting pin	DLCY
11	Pivot pin for Cam	DLCA
12	Cotter pin	
11	Pivot pin for link	DLB
12	Cotter pin	DLS
7	Spring	

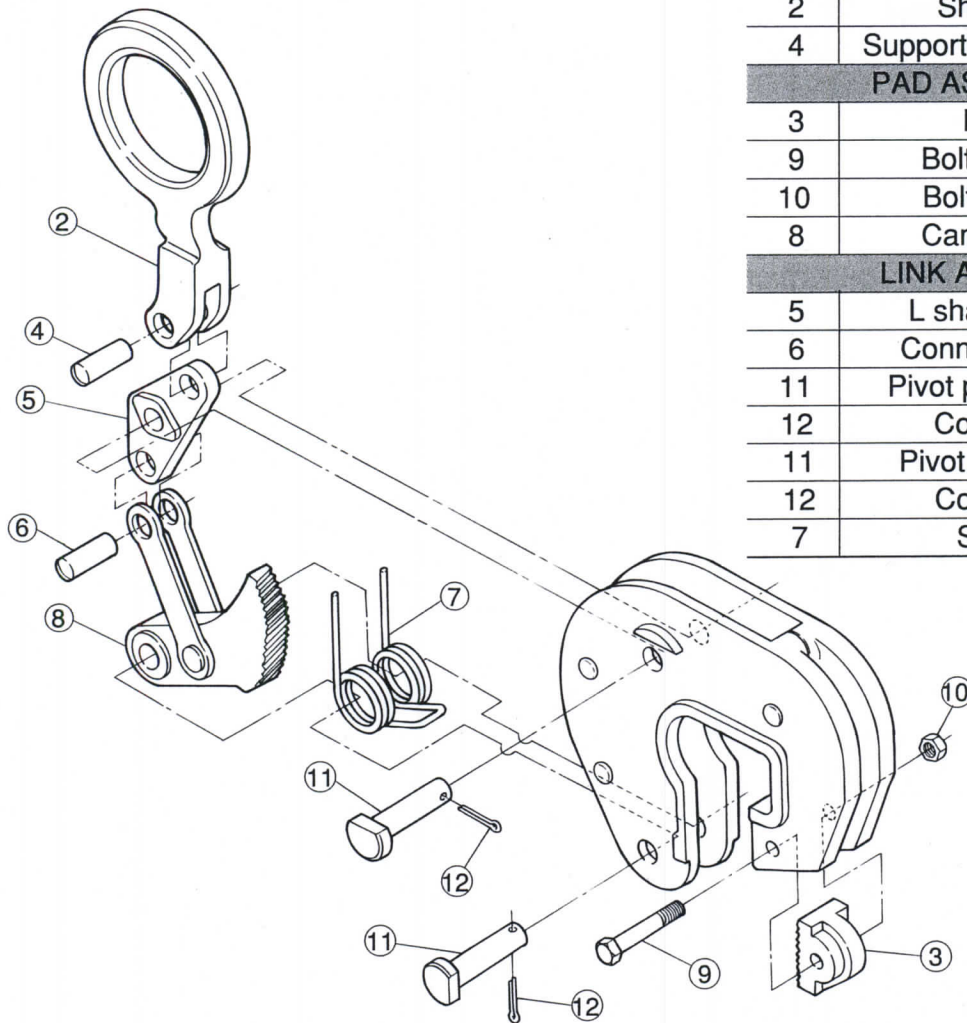

## Replacement procedure for cam and pad

### Disassembling

#### A) PAD

1. Take out by loosening Bolt and Nut for pad.

#### B) CAM

1. Take out Cotter pin ⑫ from Pivot pin ⑪ on both shackle and cam sides.
2. Remove two Pivot pins in both shackle and cam sides form body.
3. Take out shackle, L-shaped link and cam (with rod) form body.

Then, remove Spring ⑦.

(The cam and rod cannot disassemble)

### Reassembling

#### A) PAD

Tighten Bolt and Nut for pad after installed a new pad to the position correctly.

#### B) CAM

After installed Spring onto the hole of new cam side, re-assemble in the reverse order of disassembling.

Be sure that the spring is installed with the correct position as shown in the above Parts drawings.

# Replacement procedure for cam and pad

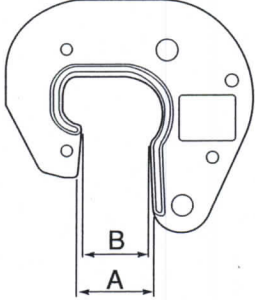
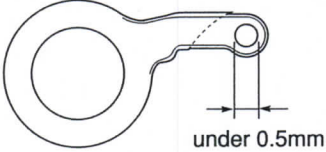
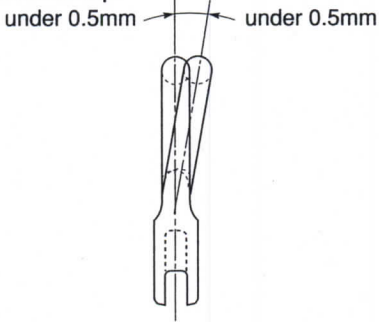
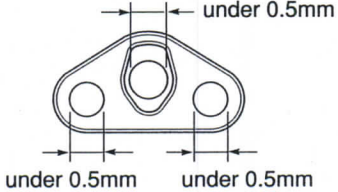
SECTION	INSPECTING METHOD	PERMISSIBLE LIMIT	CAUSES OF THE TROUBLE
<p><b>Body</b></p>	<p>Visually check or use color dyes to find cracks.</p> <p>Measure the jaw opening.</p> <p>Visually check and measure each section for other forms of deformation.</p>	<p>Dispose of the clamp when a crack is found.</p> <p>Dispose of the clamp when the difference of "A" and "B" exceeds 5%.</p> 	<ul style="list-style-type: none"> <li>* Overloading</li> <li>* Dynamic loads</li>   <li>* Overloading</li> <li>* Too large hoisting angle</li>   <li>* Overloading</li> <li>* Too large hoisting angle</li> </ul>
<p><b>Shackle</b></p>	<p>Visually check or use color dyes to find cracks.</p> <p>Visually check and measure the pin hole for wear and deformations.</p> <p>Visually check and measure for bends or other forms of deformations.</p>	<p>Dispose of the clamp when a crack is found.</p> <p>Replace when the deformation exceeds 0.5mm.</p>  <p>Replace when deformation or play exceeds 5 degrees from the center or the clamp.</p> 	<ul style="list-style-type: none"> <li>* Overloading</li> <li>* Dynamic loads</li> <li>* Too large hoisting angle</li>   <li>* Natural wear from use</li> <li>* Insufficient lubrication</li>   <li>* Overloading</li> <li>* Dynamic loads</li> <li>* Too large hoisting angle</li> </ul>
<p><b>L shaped link</b></p>	<p>Visually check and measure for bends and other forms of deformation.</p> <p>Measure the pin hole and check for wear and deformations.</p>	<p>Replace when unusual sounds generate or when the movement is not smooth.</p> <p>Replace when the deformation exceeds 0.5mm.</p> 	<ul style="list-style-type: none"> <li>* Overloading</li> <li>* Too large hoisting angle</li>   <li>* Natural wear from use</li> <li>* Insufficient lubrication</li> <li>* Overloading</li> </ul>

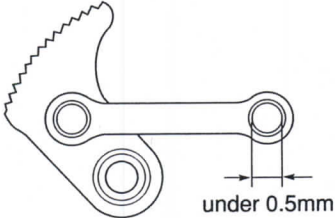
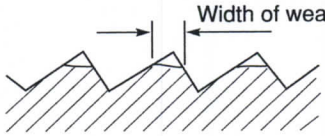
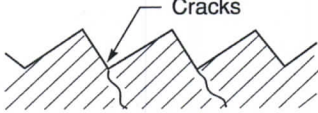
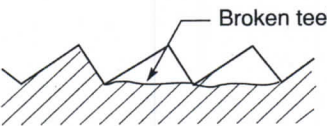
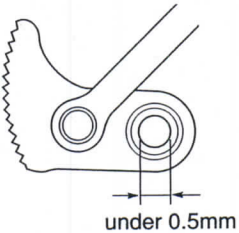

SECTION	INSPECTING METHOD	PERMISSIBLE LIMIT	CAUSES OF THE TROUBLE
Rod	Visually check and measure for bends and other forms of deformation.	Replace when unusual sounds generate or when the movement is not smooth.	<ul style="list-style-type: none"> <li>* Overloading</li> <li>* Too large hoisting angle</li> </ul>
	Visually check and measure the pin hole for wear and deformations.	Replace when the deformation exceeds 0.5mm. 	<ul style="list-style-type: none"> <li>* Natural wear from use</li> <li>* Insufficient lubrication</li> <li>* Overloading</li> </ul>
Cam and Pad	Visually check and measure the amount of wear.	Replace when the width of wear exceeds the following limits.  <p style="text-align: center;">Permissible limit of width of wear under 0.5mm</p>	<ul style="list-style-type: none"> <li>* Natural wear from use</li> <li>* Wear from clamping hardened material</li> </ul>
	Visually check or use color dyes to locate cracks at the base of the teeth.	Replace of the clamp when the cracks are found. 	<ul style="list-style-type: none"> <li>* Overloading</li> <li>* Dynamic loads</li> <li>* Too large hoisting angle</li> <li>* Damage from clamping hardened material</li> </ul>
	Visually check for broken pad teeth.	Replace when 1 tooth or more are broken. 	<ul style="list-style-type: none"> <li>* Overloading</li> <li>* Dynamic loads</li> <li>* Too large hoisting angle</li> <li>* Damage from clamping hardened material</li> </ul>
	Measure the pin hole and check for wear and deformation.	Replace when the deformation exceeds 0.5mm. 	<ul style="list-style-type: none"> <li>* Overloading</li> <li>* Too large hoisting angle</li> <li>* Natural wear from use</li> <li>* Insufficient lubrication</li> </ul>

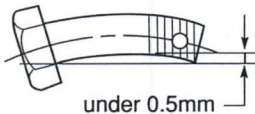
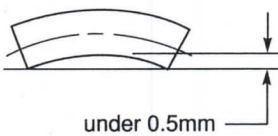
SECTION	INSPECTING METHOD	PERMISSIBLE LIMIT	CAUSES OF THE TROUBLE
Pivot pin and bolt for pad	Confirm that the pins move smoothly. There should not be a large amount of play.	Replace when the deformation exceeds 0.5mm.	* Natural wear from use * Insufficient lubrication
	Visually check or use color dyes to find cracks.	Dispose of the clamp when a crack is found.	* Overloading * Dynamic loads * Too large hoisting angle
	Visually check and measure for bends and other forms of deformation.	Replace when the deformation exceeds 0.5mm. 	* Overloading * Dynamic loads * Too large hoisting angle
Support pin and connecting pin	Confirm that the pins move smoothly. There should not be a large amount of play.	Replace when unusual sounds generate or when the movement is not smooth.	* Natural wear from use * Insufficient lubrication
	Visually check and measure for bends and other forms of deformation.	Replace when the deformation exceeds 0.5mm. 	* Overloading * Dynamic loads * Too large hoisting angle
Spring	Confirm that the spring generates a constant initial load when the cam is closed.  Confirm that there is sufficient spring force when the cam is pressed in (to maximum jaw opening).	Replace when rust or deformation reduce the spring force.  Replace when there is insufficient spring force.	* Fatigue caused by repeated use