

# SAFETY LIFTING CLAMPS

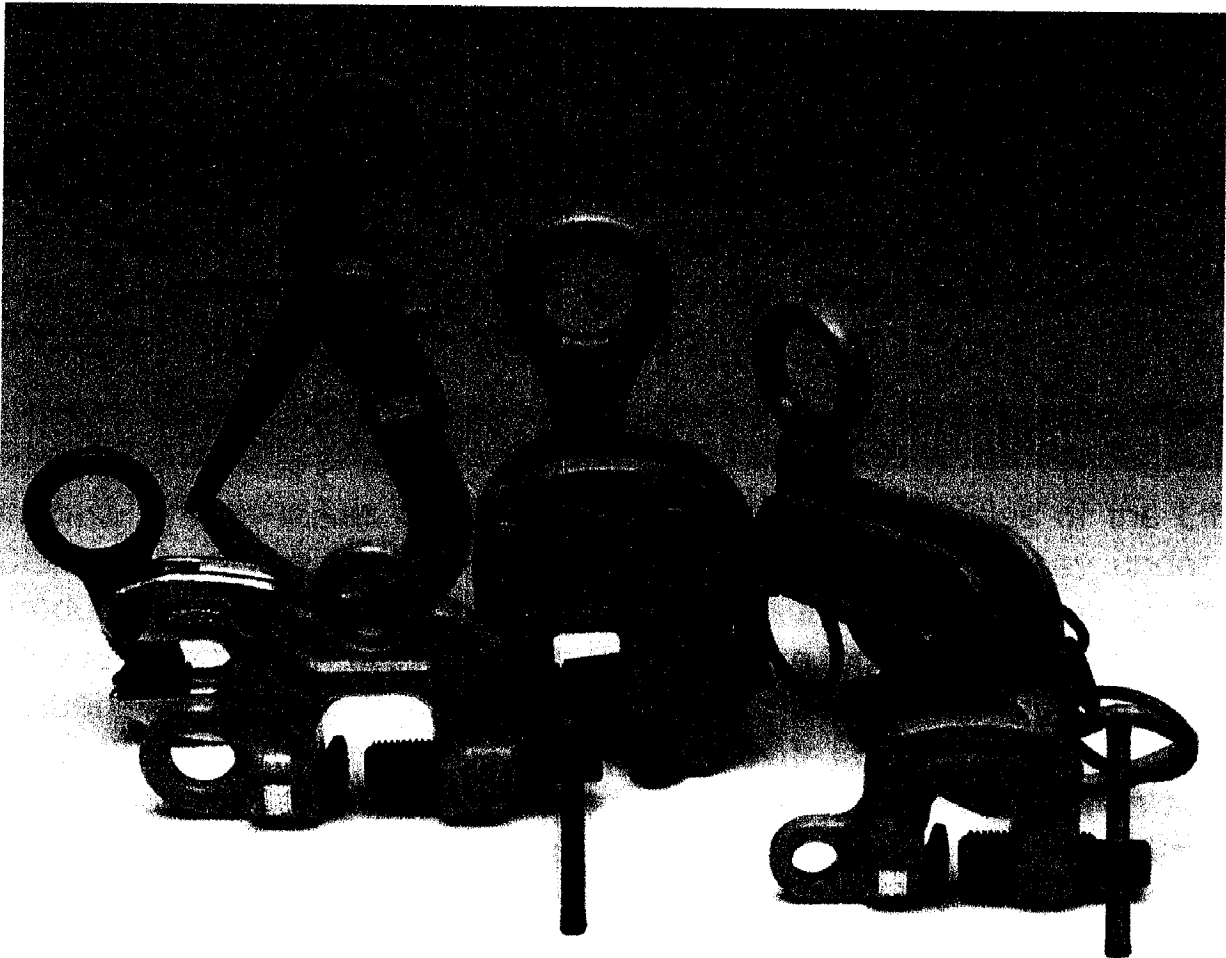

INSTRUCTION FOR OPERATION  
OF  
"SUPER" BRAND  
SUPER LOCK HOOK

SLH-N SLH-S



**SUPER** TOOL

OSAKA, JAPAN

# **Proper Handling of “Super” Lifting Clamps**

We are thankful for your purchase of our Lifting Clamps. Our Lifting Clamps (hereinafter, called “Lifting Clamp” or “Clamp”) is energy-saving lifting tools designed and developed for transportation of steel materials and other steel products.

## **Proper use of Lifting Clamps demanded**

You are kindly requested to operate the Lifting Clamps after carefully reading and understanding this instruction manual for the purpose of enhancing safety and efficiency at work.

## **Prime efficiency and economy**

The sophisticated functions, reasonableness and wide applications of the finely and carefully designed Lifting Clamps ensure best efficiency and economy.

## **Special care of safety**

We executed tensile tests with loads three times (or twice) the rated capacity and inspection numbers to individual products are attached, thus directing special attention to the safety.

## **Attachment of products and completed operation liability insurance**

In case any damages occur due to the defective qualities of the Lifting Clamps under the normal conditions of use, insurance money under the products and completed operation liability insurance will be paid for them. Please take note, however, if the damages are incurred due to intentional misbehavior or mistaken use (non-safety actions), abrasion of the clamp pads, they are not within the coverage. Never fail to post before use the application for registration for products and completed operation liability insurance attached to the clamp (return post card) after filling in all the required items of information.

# Cautions for safety operation

## Do not fail to read this instruction manual carefully before use of the Lifting Clamps.

Mistaken use of the Lifting Clamps (hereinafter to be called "Clamps") may cause troubles such as the dropping of lifted work.

Never fail to read this manual carefully for proper operation before use.

Education of "crane safety regulations," "operation manual for lifting clamps," "in-house operation standards," etc. should be provided before actual operation not only to business owners who have purchased the Clamps but also to their operators to ensure the sufficient acquisition of the knowledge of them, safety information, and cautions by the actual operators.

"Lifting clamps safety council," divide cautions in general into two designations as "Dangers" and "Cautions," which are followed in this instruction manuals.



### **DANGER:**

Indicates mistaken handling may cause a potentially hazardous situation which, if not avoided, could result in death or serious injury.



### **CAUTION:**

Indicates mistaken handling may cause a potentially hazardous situation which, if not avoided, could result in medium damage or slight injury, or could result in property damage.

Moreover, what are mentioned in the Cautions, may also result in a serious situation depending upon the circumstances. As such, do not fail to pay attention to dangers and cautions, both of which are of great importance in the proper operation of the Clamps.

## ● Meanings of Signs



The signs of  $\diamond$  and  $\triangle$  indicate that attention is to be given to the marks indicative of dangers and cautions respectively. The signs figuratively show the contents of danger or caution. (The left-side sign indicates a caution to the pinching.)





The sign indicates prohibited actions.





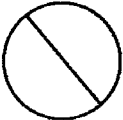

The sign of  $\circ$  indicates that an action is enforced or instructions are provided. Inside the sign or beside, any specific instruction is described. (The left-side sign indicates the requirement of a lifting at two points.)

※After reading this manual, keep it at a convenient place to which any user can gain an easy access for reference.



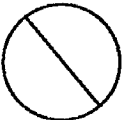

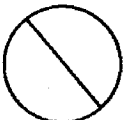
# 1. Handling in general

 <b>Danger</b>	
<ul style="list-style-type: none"> <li>● Any person, who is not well informed about the instruction manual, tags or signs of cautions, is not eligible for use of the Lifting Clamps.</li> <li>● Any person without the legal qualifications, may never operate a crane or a lifting clamp.</li> <li>● While lifting or turning the work, do not enter the area where the lifted work may fall down or fall over.</li> <li>● Do not use this lifting clamp for other purposes than lifting work.</li> </ul>	
<ul style="list-style-type: none"> <li>● Never fail to execute an inspection before use and periodical inspections.</li> </ul>	

# 2. Checks before operation

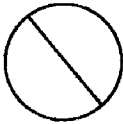

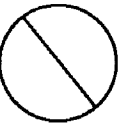

 <b>Danger</b>	
<ul style="list-style-type: none"> <li>● Do not use a clamp not complying with the operation method.</li> <li>● Do not use a defective clamp with deformation, cracks, abrasion malfunction, etc.</li> <li>● If the work to lift is under the following conditions, do not use the clamp. (fragile materials, high-hardness materials, low-hardness, extremely low-hardness materials, or members with the large inclined gripping part with more than 8 degrees inclination.)</li> </ul>	
<ul style="list-style-type: none"> <li>● Check on the model type of the Clamp, rated capacity, jaw opening diameter, and designation of completion of periodical inspections.</li> <li>● The load of the work to lift shall be within the allowable range of the basically applicable load of the clamp.</li> <li>● The thickness of the work to be lifted should be within the allowable clamping range.</li> </ul>	
 <b>Caution</b>	
<ul style="list-style-type: none"> <li>● Do not use the clamp under the following conditions. (The temperature of the work to be lifted is more than 150 °C, or less than -20 °C, or the attachment of such chemicals as any acid or alkaline.)</li> </ul>	
<ul style="list-style-type: none"> <li>● Sling to be used for the clamp should be in conformity to the lifting operation.</li> </ul>	

### 3. Methods of use and lifting operation

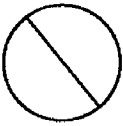

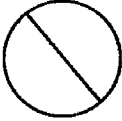

 <b>Danger</b>	
<ul style="list-style-type: none"> <li>● Do not use the Clamp in the following way of lifting: (lifting two or more works at one time in any style regardless of the number of clamps used or one work with side gripping )</li> <li>● Do not use the Clamp to pull out a steel plate from the piles or lifting them vertically.</li> <li>● Do not use the Clamp when there's a strong wind to avoid any danger.</li> <li>● Do not use the Clamp with a hydraulic shovel.</li> </ul>	
<ul style="list-style-type: none"> <li>● Install two or more Clamps in a balanced way to keep the work's balance.</li> </ul>	
<ul style="list-style-type: none"> <li>● The lifting and hooking angle of the Clamp should be within the allowable angles according to the specifications of respective types.</li> <li>● The work is to be inserted to the innermost end of the Clamp opening.</li> <li>● When you use the Clamp with a locking system, never fail to make the lock on when the Clamp is used.</li> </ul>	
 <b>Caution</b>	
<ul style="list-style-type: none"> <li>● If oil, paint, scales, rust, etc. are on the gripping pad, do not use the Clamp.</li> <li>● Do not drop or drag the Clamp along the ground .</li> </ul>	

### 4. The operation of a crane

 <b>Danger</b>	
<ul style="list-style-type: none"> <li>● Never lift the work weighing more than the rated capacity.</li> <li>● Do not operate the crane in such a way that an impacting load to the work or the Clamp is given.</li> <li>● Do not allow a man to stand on the lifted work. Never use the Clamp for the purpose of carrying a man.</li> <li>● Do not lift the earth itself.</li> <li>● During the course of lifting the work, do not release the lock of the Clamp.</li> <li>● Do not let the Clamp, which has been removed from the work, collide with the work or with any materials nearby.</li> </ul>	

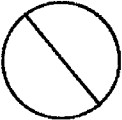
<ul style="list-style-type: none"> <li>● When you wind up the wire by the crane and notice the load at the lifting ring, stop the operation temporarily for safety checking (depth of the work into the Clamp opening; status of locking).</li> <li>● Stop the operation of the crane just before the work reaches the ground, check the following items of things: (Slant and falling over of the work; security at the landing site and its surroundings)</li> </ul>	
 <b>Caution</b>	
<ul style="list-style-type: none"> <li>● Do not operate the crane in such a way as to drag the work along the ground.</li> <li>● Do not step away from the crane (winder, etc.) operating position while keeping the work being lifted with the Clamp.</li> </ul>	
<ul style="list-style-type: none"> <li>● Hoisting and lowering operation by the crane should be made slowly and carefully.</li> </ul>	

## 5. Maintenance, storage and remodeling

 <b>Danger</b>	
<ul style="list-style-type: none"> <li>● Never remodel the Clamp or its accessories.</li> <li>● Do not weld or heat the Clamp or its accessories.</li> <li>● Do not use any other parts than our company's brand-name parts.</li> <li>● Segregate and store the Clamps with any repairing needs at a different location to avoid the use by mistake.</li> </ul>	
<ul style="list-style-type: none"> <li>● Maintenance and repairing work must be done by a person with the expertise designated by the business owner.</li> <li>● When you detect abnormality with the Clamp, do not use it and immediately repair or dispose of it.</li> <li>● Remove, if any, paint or mud sticking to the moving parts of the Clamp, cams, and pads.</li> </ul>	
 <b>Caution</b>	
<ul style="list-style-type: none"> <li>● Conduct repairing and maintenance only when no work is at the Clamp.</li> <li>● Conduct repairing and maintenance after posting such a sign as "Under Inspection".</li> <li>● Never fail to lubricate any rotating parts of the Clamp (around the pin), guide grooves, sliding parts, etc.</li> <li>● Store Clamps inside a room.</li> </ul>	

**Note:** Please contact our company's sales agents or sales offices to take advantage of our services for the items of inspections and maintenance standards associated with assembly and disassembly

# INSTRUCTION FOR USE

Keep these instructions within easy access of operators.

It is important that operators understand these warnings and instructions before using.

## WARNINGS

- Select proper size clamp for the job. Determine the weight of the plate, H-beam or steel structure to be lifted!

Do not exceed limited working load shown on clamp!

Plate thickness must be within grip range shown on clamp. In some cases with hardened plates, light plates (less than 1/5 of capacity marked on the clamp) and thin plates (less than 1/4 of the maximum clamping range), the clamping force of the clamp will be reduced. In these cases, confirm that the clamp has positive grip before lifting!

- Inspect clamp! If cam or pad teeth are worn, or if clamp is damaged, do not use!
- All personnel must stand clear of load while it is being lifted or moved!
- Take up slack slowly! Do not bounce or jerk load!
- Use clamp with correct manners after read following illustration for lifting and clamping manners!
- Never use a steel lifting clamp (hereafter called clamp) on material other than steel!
- When operating clamps, always maintain a firm footing and only operate from a location that will be safe at all times!
- Before lifting the load, confirm that clamps are in good condition and functioning properly!
- Always protect the surface of cam and pad from weld spatters or other damaging contaminants! The surface of the load must always be clean and free of scale, grease, paint, dirt and coating or other foreign matters that can reduce friction!
- Note that the service life of clamps is reduced considerably when stainless steel sheets or high-tensile steel are clamped! Do not use clamps for lifting high-tensile steel (over 300HB) or soft steel (under 80HB)!
- Never vertically lift material that tapers down to the edge!
- Never vertically lift with horizontal or lateral clamps!
- Never lift more than one steel plate at a time!
- Always use slings correctly! Pay special attention to the correlation between the lifting angle and the rated load!
- Never operate clamps unless the load is properly centered!
- After the load has been lifted a few centimeters, confirm that the load is well balanced!
- Never allow the operator's attention to be diverted when operating clamps and never leave the suspended load unattended!
- Never modify clamps!
- Only use genuine parts when repairing clamps!
- Please refer, also, to the warnings in the catalog!

# Selection Standard of SUPER LIFTING CLAMPS in Two-Point Lifting.

The maximum allowable load of a clamp varies with the lifting angle. The larger the angle, the more increases the load applied to clamp and rope and the more decreases the lifting efficiency as shown in the table below. Therefore, considering the lifting angle, select a clamp of proper capacity.

## Correlation between lifting angle and safe load (in two-point lifting)

Clamp name and item no.												
Vertical lifting clamps (SVC-H,SVC-L,SVC)							0°	30°	45°	60°	90°	120°
Lateral horizontal lifting clamps (HLC-H,HPC)												
Structure clamps (HLC-S,HLC)												
Screw cam clamp (SCC)												
Lifting hook(HHC)												
Lifting efficiency →												
Clamp capacity(per 2pcs)						Safe load per 2clamps (tons)						
○	○	○	○	○	○	0.5 × 2 pcs= 1 ton	1	0.98	0.92	0.86	0.7	0.5
				○		0.75×2 pcs= 1.5ton	1.5	1.44	1.38	1.29	1.06	0.75
○	○	○	○	○	○	1 × 2 pcs= 2 ton	2	1.9	1.8	1.7	1.4	1
				○		1.5 × 2 pcs= 3 ton	3	2.9	2.8	2.6	2.1	1.5
○	○	○		○		2 × 2 pcs= 4 ton	4	3.8	3.7	3.4	2.8	2
○	○	○	○	○	○	3 × 2 pcs= 6 ton	6	5.8	5.5	5.2	4.2	3
○	○	○		○		5 × 2 pcs=10 ton	10	9.6	9.2	8.6	7	5
				○		6 × 2 pcs=12 ton	12	11.5	11	10.3	8.4	6
○						10 × 2 pcs=20 ton	20	19.2	18.4	17.2	14	10

★ In this table, lifting angles are given from 0° to 120°, but it is recommended for the sake of safety to keep within 60° in the case of two-point or four-point lifting.

★ When using two or more clamps, it is safe to use those of same capacity.

### HOW TO SEE THE TABLE

Example: To lift a 5.5-ton steel plate at two points, at the following lifting angles.

#### a. When lifting angle is 0° (vertical lifting):

- (1) In the column of 0° lifting angle, find the smallest value over 5.5 tons, then "6" is picked up in the sixth frame from the top.
- (2) Look to the left from the "6" frame, and look for the clamp capacity. That is, "3×2 pcs=6 tons," which means two 3-ton clamps should be used.

#### b. When lifting angle is 60° (Steel plate weight is same):

- (1) In the column of 60° lifting angle, find the smallest value over 5.5 tons, then "8.6" is picked up in the seventh frame from the top.
- (2) Look to the left from the "8.6" frame, and look for the clamp capacity. That is, "5×2 pcs=10 tons," which means two 5-ton clamps should be used.

### WARNING

In this case, one 3-ton clamp and one 6-ton clamp cannot be combined. Mathematically, the capacity in tons is sufficed but it is very dangerous.



# "SUPER" CLAMPS Maintenance and Repair

Check periodically, repair and replace parts, and use correctly in order to use the clamps over the full service life, safely.

## Common Check Points

- Check the main body for distortion or flaw.
- Make sure the opening is normal (check if widened)
- Check if the shackle is distorted.
- Check the shackle pin hole for widening or looseness.
- Check cam and pad teeth for defect or wear.
- Check cam pin hole in main body for widening.
- Check if cam pin is worn and thinned.
- Check the performance of tightening lock (handle, lever), shackle, and other mechanism.

Check all the listed items. Inspect according to the Checking Standard.

Most items may be checked visually or by touching. To measure the safety point distance and opening size, use slide calipers or the like to obtain precise measurements.

When clearance between bolt and hole exceeds 1mm, and deflection of cam or shackle becomes excessive.

### DISCARD

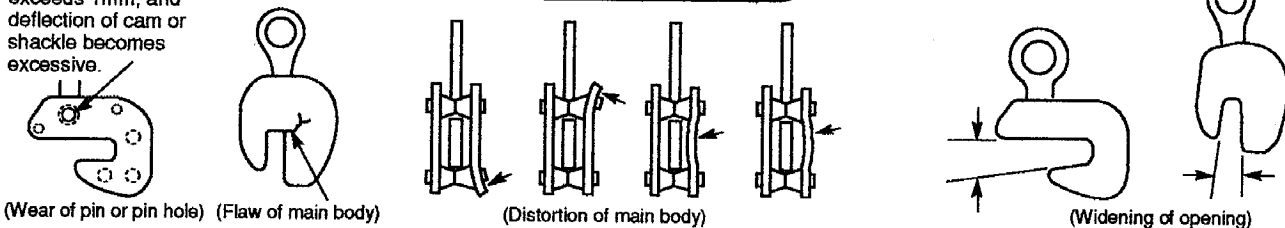

Discard the clamp if obvious flaw or distortion is found in the main body. Defects in the main body can not be repaired in the light of safety. The main body may be cracked or deformed only after several uses if it is used incorrectly. Dent or swelling of main body, or

widening of opening may be caused by overload or wrong manner of use. If the defect is repaired by welding, hardening, or pressing, the original strength is not recovered. When used and controlled correctly, the clamp may be safely used for along time only by replacing parts.

### REPLACE

(Shackle)

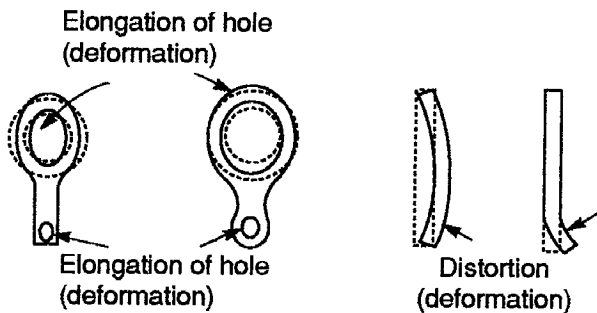

Regard the shackle as part of body if deformed as shown above, replace it immediately. If deformed shackle is straightening up, the initial strength is not restored.

(Cam and pad)

Wear limit width of cam, pad  
0.5mm more

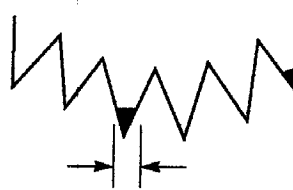

When worn as shown above, replace immediately. Or, if not worn, when even one tooth is missing, replace also immediately. The wear rate is accelerated when stainless steel or other hard material is clamped. Or when plates of specified thickness are continuously clamped, only particular threads will be worn in a short time. In such a case, too, replace immediately.

Besides, replace the support pins, bolts, springs, and other parts according to the Checking Standard.

## Check Twice to Confirm Safety.

Check the type capacity of clamp. Is the wire rope proper? How about its size and length? Overloaded or not? Where's the center of gravity? Is the material inserted fully? Is it locked securely?

Lift at two points for an object longer than a meter. Lift at three or four points where the center of gravity is

hard to locate. Is the lifting angle proper? Check all these items, and confirm them once again.

Lift, carry, touch down slowly. Be careful not to hit against surrounding objects while carrying. Keep off hands. Do not enter hazardous zone. Always pay attention to safety.

# LIFTING ANGLE AND SAFE LOAD OF WIRE ROPE

The maximum allowable load (safe load) of wire rope also varies with the lifting angle. Therefore, select a wire rope of proper diameter in consideration of the lifting angle. (The breakage load specified in table below refers to No.4. 6×24A class of JIS G3525.)

## Correlation between Lifting Angle and Safe Load of Wire Rope (in two-point lifting)

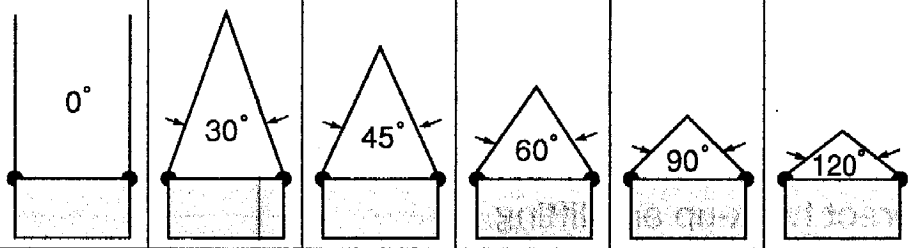
D Wire rope dia (mm)	$\sigma$ Break-age load (tons)	W Safe load (on one rope) $W=\sigma/S$ (safety factor S=6) (tons)						
			100%	96%	92%	86%	70%	50%
(Changes in lifting efficiency due to lifting angle.%)								
Max.allowable load (safe load) on two wire ropes (tons)								
8	3.21	0.54	1.08	1.04	0.99	0.93	0.76	0.54
9	4.06	0.68	1.36	1.31	1.25	1.17	0.95	0.68
10	5.02	0.84	1.68	1.61	1.55	1.44	1.18	0.84
11.2	6.29	1.05	2.1	2.02	1.93	1.81	1.47	1.05
12.5	7.84	1.31	2.62	2.52	2.41	2.25	1.83	1.31
14	9.83	1.64	3.28	3.15	3.02	2.82	2.3	1.64
16	12.8	2.13	4.26	4.09	3.92	3.66	2.98	2.13
18	16.2	2.7	5.4	5.18	4.97	4.64	3.78	2.7
20	20.1	3.35	6.7	6.43	6.16	5.76	4.69	3.35
22.4	25.2	4.2	8.4	8.06	7.73	7.22	5.88	4.2
25	31.3	5.22	10.44	10.02	9.6	8.98	7.31	5.22
28	39.3	6.55	13.1	12.58	12.05	11.27	9.17	6.55
30	45.1	7.52	15.04	14.44	13.84	12.93	10.53	7.52
31.5	49.8	8.3	16.6	15.94	15.27	14.28	11.62	8.3
33.5	56.3	9.38	18.76	18.01	17.26	16.13	13.13	9.38
35.5	63.2	10.53	21.06	20.22	19.38	18.11	14.74	10.53

Note For four-point lifting, multiply the corresponding figure in the table by 2 to find the maximum allowable load (safe load).

## Simplified calculation method of wire rope diameter and safe load(one-point lifting)

1)  $D = \sqrt{W \times C}$

2)  $W = \frac{D^2}{C}$

Where D : wire rope diameter(mm)  
W : safe load(tons)  
C : constant=120  
(safety factor S=6)

★To find the diameter of wire rope for 3 tons :

①  $D = \sqrt{W \times C}$

$D = \sqrt{3 \times 120} = \sqrt{360} = 19 \rightarrow 20\text{mm}$

★To find the service load (safe load) on 25mm diameter wire rope.

②  $W = \frac{D^2}{C}$

$W = \frac{25^2}{120} = \frac{625}{120} = 5.2 \rightarrow 5.2\text{ton}$

# SUPER LOCK HOOK

SLH-N  
SLH-S

## ■ Applications

This Hook is optimal for lifting work for setting or removing floor steel plates used in civil engineering and construction sites. And it can also be used for a variety of lifting work by the use of a wire rope or sling belt or direct hook-up and lifting.

## ■ Features

1. It is easier to hook up or remove a work such as floor steel plate by or from the Hook because the mouth can be widely opened.
2. In case of lifting a floor steel plate, just inserting the end of the Hook through the work by 30mm or more ensures an automatic application of closure lock on the opening, making the work safe and easy.
3. The main parts of the Hook are made of special metal alloy molded and forged with optimal heat treatment, ensuring its excellent toughness and durability.

## ■ Specifications

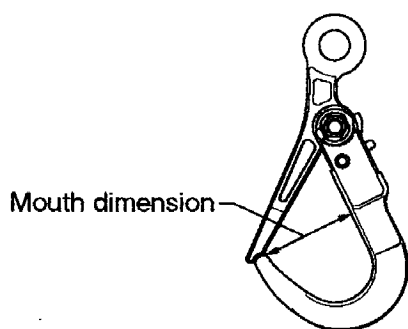

Standard Type

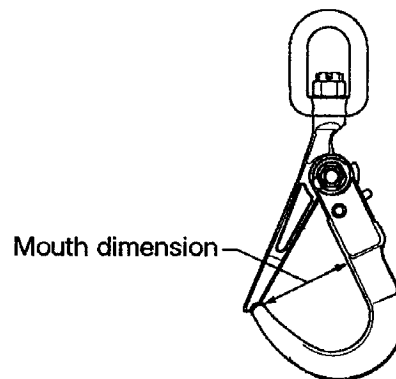

Swivel Type

	Product No.	Capacity (ton)	Mouth dimension (mm)	Weight (kg)
Standard Type	SLH 1N	1	80	2.5
	SLH 2N	2	105	3.2
	SLH 3N	3	105	3.4
Swivel Type	SLH 2S	2	105	4.2
	SLH 3S	3	105	4.5

# Part name **SLH-N·SLH-S**

No.	Part name	Part reference No.	Quantity
1	Shackle	SLHH	1
2	Lever	SLHL	1
3	Shackle supporting bolt	SLHB	1 each
4	Shackle supporting nut		
5	Spring pin for shackle		
6	Lever supporting bolt	SLHC	1 each
7	U-shaped nut		
8	Spring	SLHS	1
※ 9	Swivel	SLHA	1
※ 10	Castle nut	SLHN	1 each
※ 11	Washer		
※ 12	Spring pin for swivel		

Note 1: At time of placing an order for part, write down nominal capacity and N or S after part reference No.

(Ex. SLHH2N for "Shackle for SLH2N")

(Ex. SLHL3S for "Lever for SLH3S")

Note 2: Parts with "※" mark are applicable only to Swivel Type.

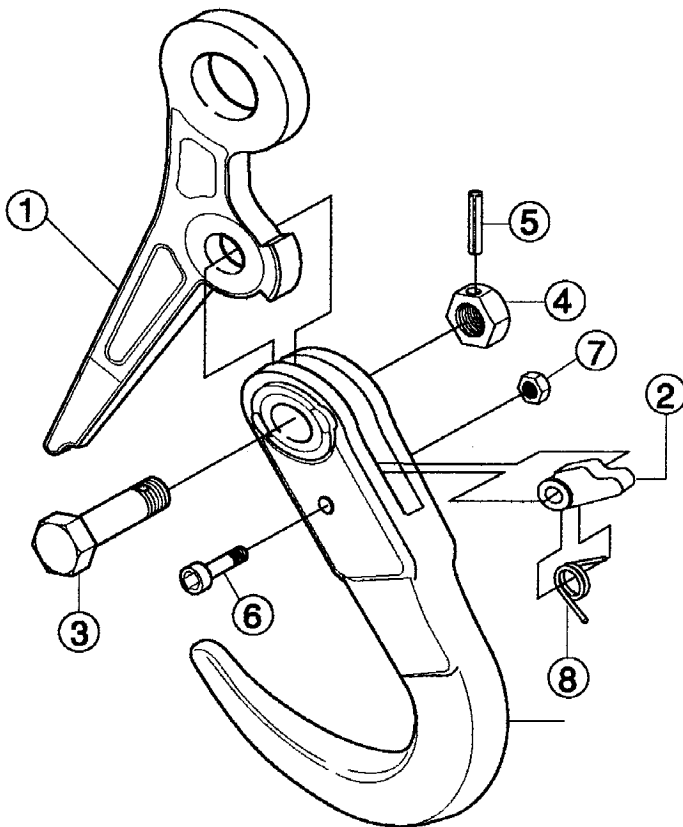

Standard Type

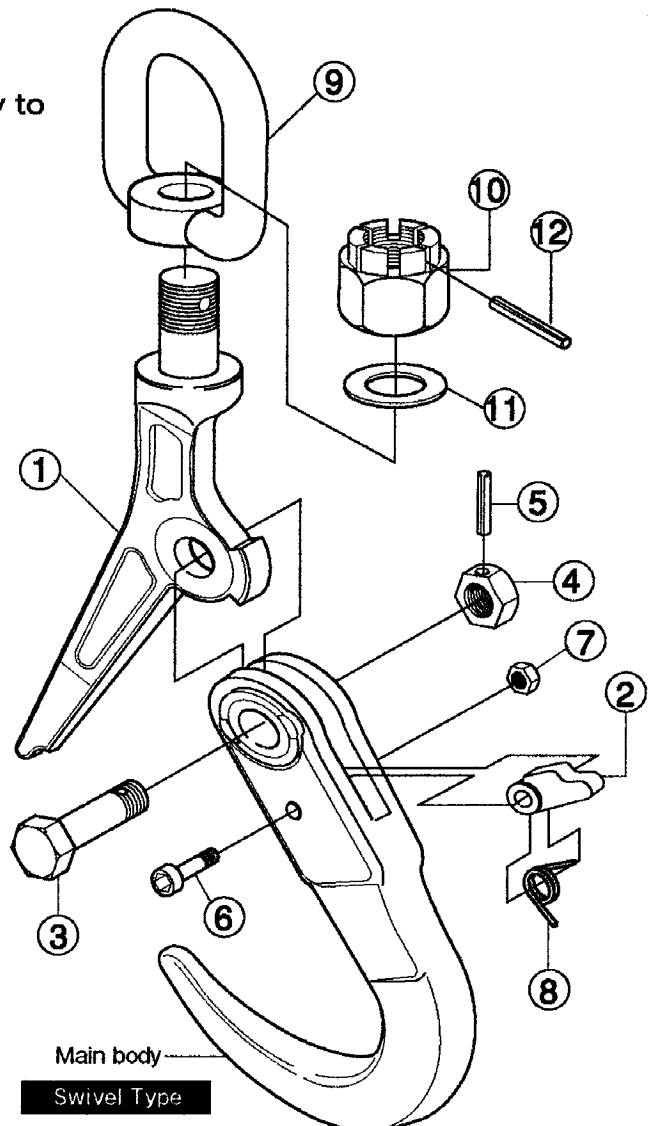

Main body

Swivel Type

## ■ Operating instruction (common to Standard Type and Swivel Type)

### 1. How to operate

- ① When you press down the lever, the shackle is in the free status. (Fig. 1)
- ② While keeping the lever pressed down, rotate the shackle to a place of contact with the main body to make the mouth fully opened. At this time, take care not to have your finger pinched between the shackle and the main body. (Fig. 2)
- ③ When you take your finger off the lever, the shackle is fixed with the mouth kept open. Hook up a work under this status.
- ④ When you add force to the shackle in the closing direction, it rotates and closure lock is applied.
- ⑤ In case of lifting a floor steel plate, when you insert the end of the Hook through the hole of a floor steel plate by 30mm or more in the state of ③ and lift it up, then the shackle is automatically closed and closure lock is applied.
- ⑥ When you remove the work from the Hook, follow the operational procedure from ① to ③.

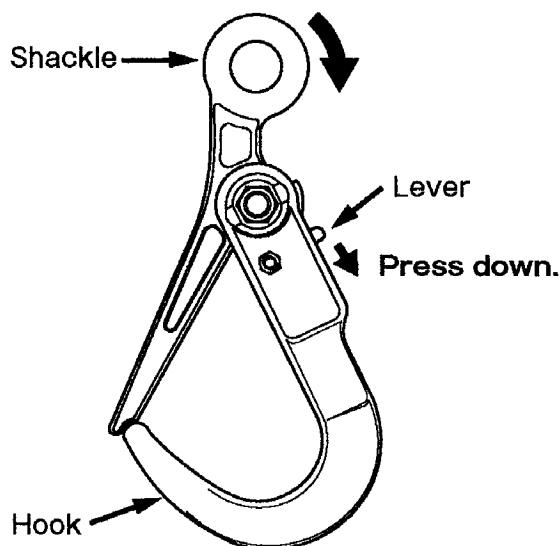

(Fig. 1)

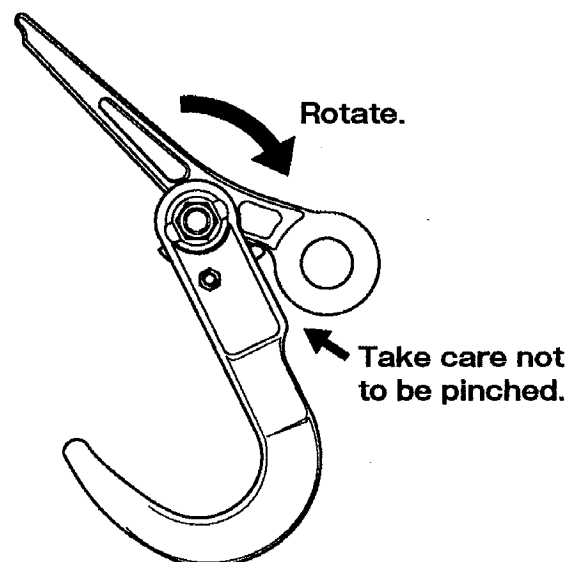

(Fig. 2)

## 2.How to lift the work

### ① In case of using the Clamp for lifting floor steel plate

(1) Check to see that the hole of a floor steel plate is appropriate in size and dimension for hooking. (Fig. 3)

- If the position of a hole for hooking is more than 60mm away from the end of the plate, a swinging of the plate may cause the end of the plate to hit the shackle and damage some of the related parts, so that the use of such a plate is to be avoided. (Fig. 4)
- If the diameter of a hole for hooking is less than 60mm, the hook part cannot be inserted to the full, giving biased overload to the end of the hook, so that the use of such a plate is to be avoided. (Fig. 5)

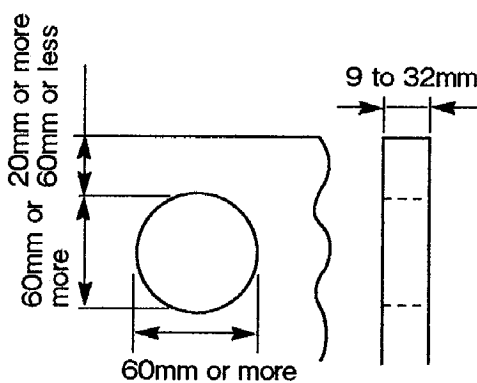

(Fig. 3)

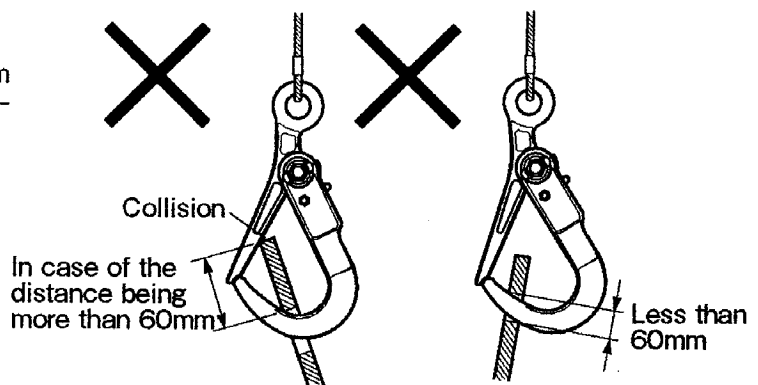

(Fig. 4)

(Fig. 5)

(2) Insert the end of the hook through the hole of a floor steel plate by 30mm or more, while keeping the shackle in the open status. (Fig. 6)

- If you insert the end of the hook through the hole around the end of the plate, the end of the shackle may collide with the plate, disabling an application of closure lock. So, be sure to insert the end of the hook through the hole from above. (Fig. 7)

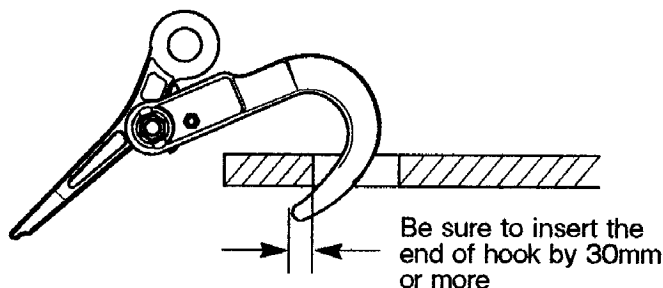

(Fig. 6)

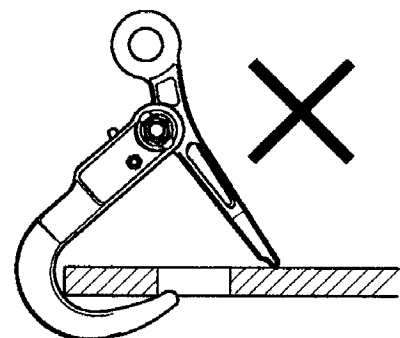

(Fig. 7)

(3) Vertically lift up the plate without giving impact on it. (Fig. 8)

- As you lift the plate upward, the floor steel plate rotates and closure lock is automatically applied as shown in (Fig. 9). If the plate does not rotate smoothly, stop the lifting work and lower the plate and then restart lifting up.

- As there is a risk of the plate moving in an unexpected direction at time of lifting up, do not enter the specified danger zone.
- When you lift up the installed floor steel plate, which may be buried in the ground or closely contacted with another, be careful about overloading.

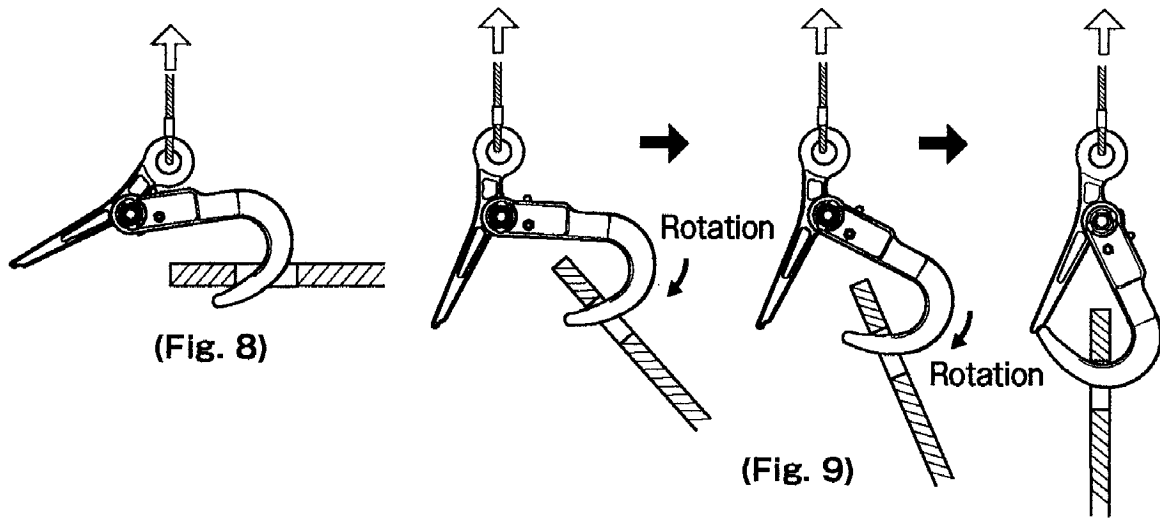

(4) When you move the plate after lifting it up, slowly move it without swinging it or giving impact on it. And be sure to be careful about strong wind and confirm that there is no worker in the danger zone.

(5) When you land the plate on the ground, lower it in the same direction as when lifting it up. (Fig. 10)

- If the hook becomes slanted as the plate is slanted, re-lift it up and then lower it. If you lower the plate with the hook kept slanted, it may give biased overweight to the hook, damaging the hook. (Fig. 11)
- Do not lower the plate in the opposite direction to that in which the plate is lifted up. If lowered in the opposite direction, the plate may collide with the end of the hook or the end of the shackle, damaging them. (Fig. 12)

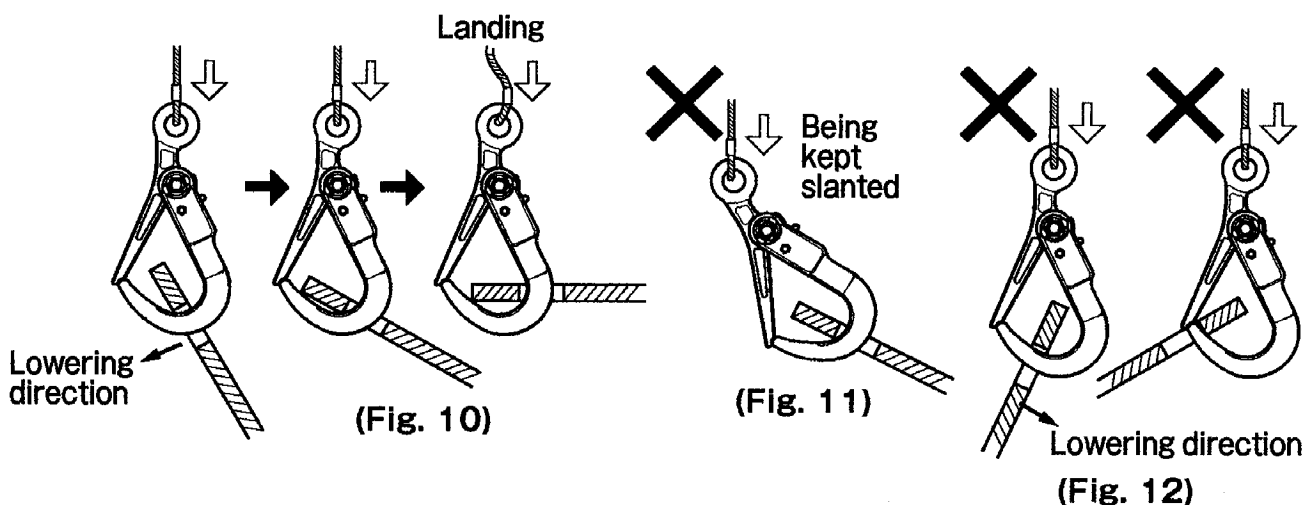

(6) After having landed the floor steel plate, press down the lever to put the shackle in the open status. Press down the upper part of the hook in the arrow-head direction and rotate the hook to remove it from the plate. If it cannot be removed, forcibly remove it with a steel bar. (Fig. 13)

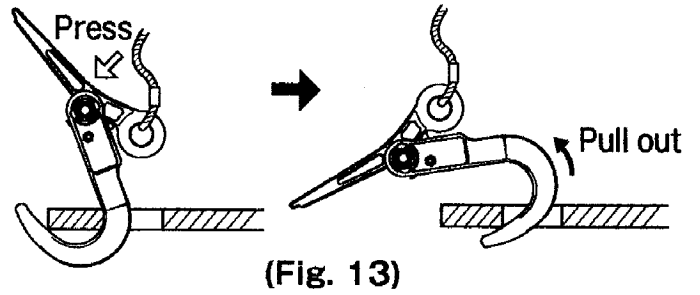

(7) When you stack floor steel plates in piles, don't overlap the holes, and keep a clearance of 35mm or more between plates. (Fig. 14)

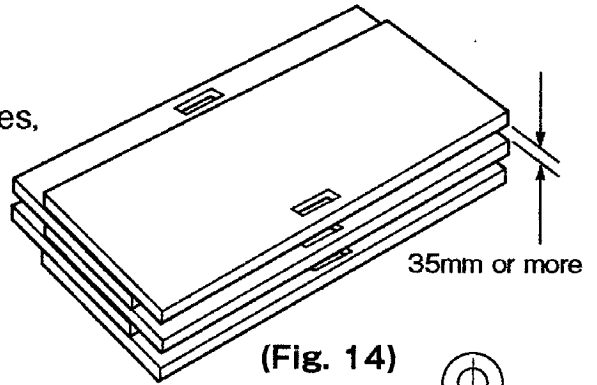

② In case of using the Clamp with wire rope or sling belt

(1) When you apply the wire rope, apply it at the center of the hook.

- Be sure not to apply the wire rope in the area within 50mm from the end of the hook. The rope may slip in the direction of the end of the hook and be removed. (Fig. 15)

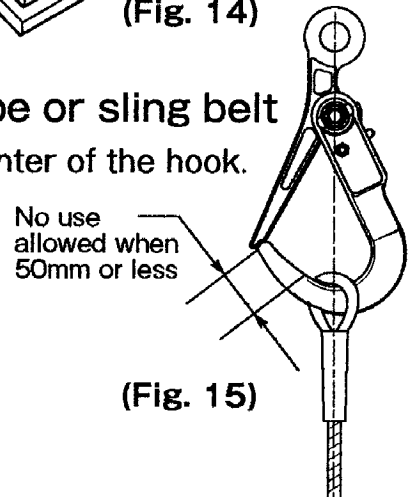

(2) In case of lifting the work at two points of place, the lifting angle shall be within 30 degrees.

- In case of lifting the work at two or more points of place, it is safe to use master ring. (Fig. 16)
- Avoid applying biased overweight to the hook by working out the center of gravity of the work. If the work is lifted up with biased overweight on the hook, the ring of the rope may slip toward the end of the hook and be removed from the mouth. (Fig. 17)

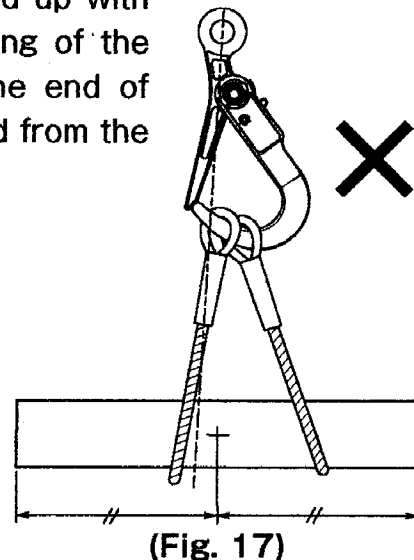
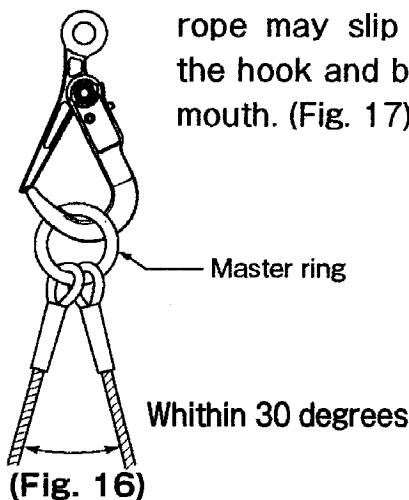



(3) Be sure not to directly apply load to the mouth of the hook and the shackle. Application of load to either of them may cause a forced opening of the shackle, removing the rope from the hook.

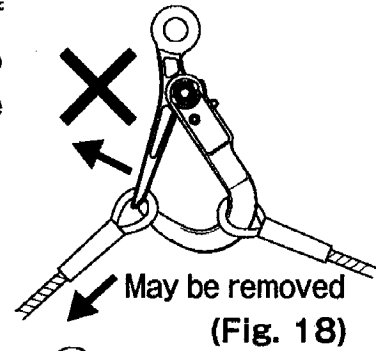

(4) Never apply a folded rope on the hook. Be sure to have the eye part of the rope to be hooked. (Fig. 19)

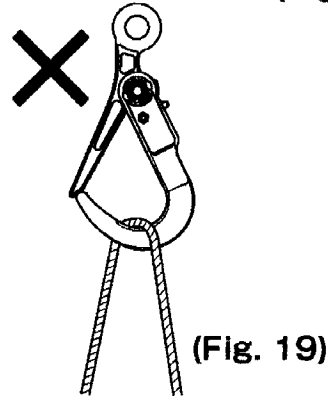

③ In case of using the Clamp for lifting the eye piece

Do not use an eye piece whose shape and dimensions are different from those specified below. (Fig. 20)

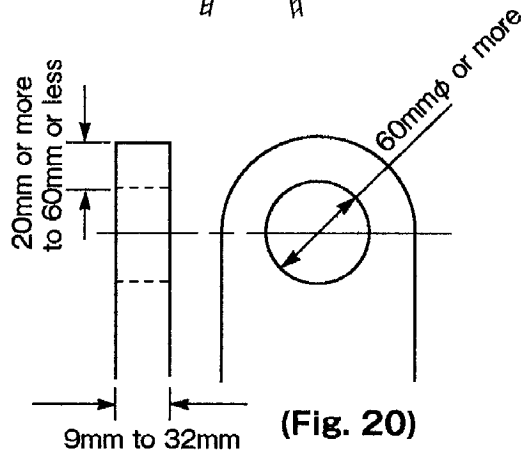

**3. Disassembly/assembly procedures**

① Disassembly procedure (Follow (1) to (2) for Standard Type; and (1) to (3) for Swivel Type)

- (1) Remove the spring pin fixing the shackle supporting nut with a pin punch and remove the shackle supporting nut and then shackle supporting bolt and the shackle.
- (2) Remove the U-shaped nut fixing the bolt for the lever, and then remove the bolt for the lever, and the spring.
- (3) Remove the spring pin fixing the castle nut with a pin punch, and remove the castle nut and then the washer and the swivel.

② Assembly procedure

Follow the reversed work procedure of disassembly.

## ■ Cautions

- Use this Clamp within the allowable load.
- Do not use this Clamp for lifting works of other shape and dimensions than specified herein.
- Be sure to lift the work in such a way that the work is put on the straight line of lifting direction. Do not lift the work with the hook slanted or slantwise to the shackle (swivel).

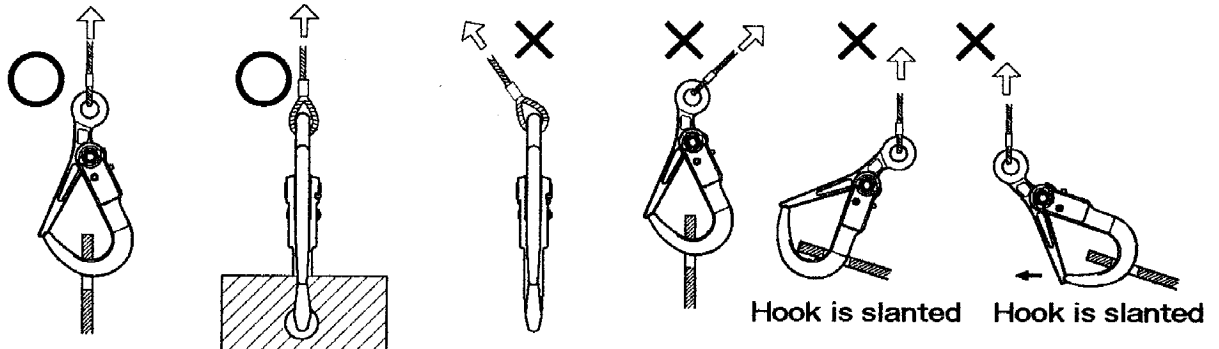

- Do not apply this Clamp to any other work than specified herein such as pulling planks out.
- Do not lift two or more works at one time.
- Do not give any impact to the work or the hook.
- Be sure to execute a checking/inspection work before use.
- Do not remodel the unit. Application of heat or any modification may cause a substantial degrading of the quality (strength) of the Clamp.

## ■ Others

### 1. Inquiry about repair parts/repairing

If your Clamp requires repair parts or repairing, stop using this Clamp and then get in contact with any branch office or sales office of Super Tool Co., Ltd. for inquiries.

### 2. About liability insurance

Insurance has been arranged in such a way that compensation will be paid for any damages to this Clamp caused by any defect in quality under normal conditions of use.

(Provided, however, that compensation is paid within the limit of indemnity.)

Be noted that the following cases are not covered by the insurance.

(1) In case of lifting the work of more than the rated capacity.

(2) In case of the user's mistake in handling or own remodeling.

In addition, please fill in designated items in the application form for registration in products liability insurance attached to this Clamp and be sure to post it before use of this Clamp.



## ■ Daily inspection

Daily inspection and maintenance is required for safety and prevention of the degradation of efficiency in operation.

1. Checking for damages such as flaws and cracks on the respective parts of the hook and the shackle (swivel).
2. Checking of whether bolts, nuts, pins, etc. are properly installed.
3. Checking of whether each part is properly actuated and lubricated.
4. Refer to the maintenance standards for other details.

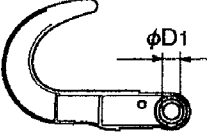
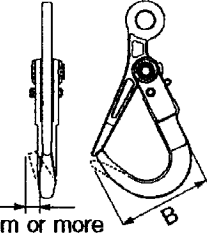
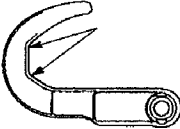
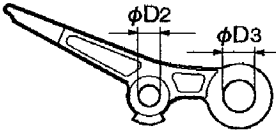
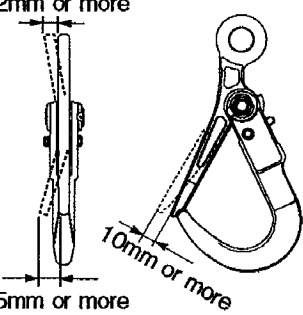
# Maintenance standards

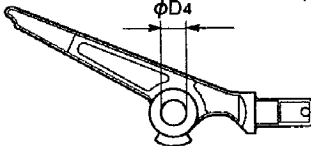
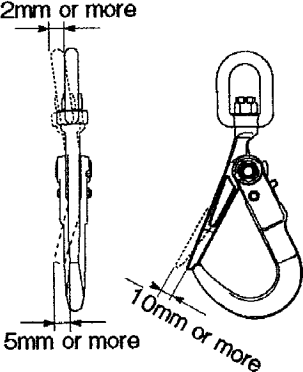
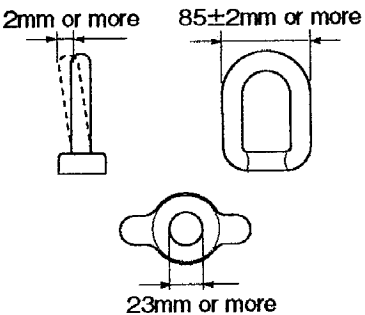
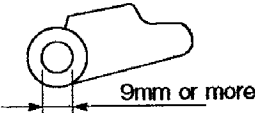
Items	Inspection method	Limit of use	Major causes of defects	Counter-measures														
<p><b>Main unit</b></p>	<ul style="list-style-type: none"> <li>● Check for flaws or cracks. (by visual check or color check)</li> <li>● Check for abrasion or deformation of bolt hole. (by measuring device)</li> <li>● Check for deformation in any part. (by measuring device)</li> <li>● Check for abrasion or deformation of lifting parts. (by visual check)</li> </ul>	<ul style="list-style-type: none"> <li>● When they are found by visual check.</li> <li>● When the hole is deformed or abraded by 0.5mm or more.                              </li> <li>● When the shackle is deformed by more than designated below.                              <table border="1" data-bbox="577 891 976 1079"> <thead> <tr> <th>Product No.</th> <th>D1</th> <th>B</th> </tr> </thead> <tbody> <tr> <td>SLH1N</td> <td>17mm or more</td> <td>128mm or more</td> </tr> <tr> <td>SLH2N</td> <td rowspan="4">21mm or more</td> <td>153mm or more</td> </tr> <tr> <td>SLH2S</td> <td rowspan="3">156mm or more</td> </tr> <tr> <td>SLH3N</td> <td rowspan="2">156mm or more</td> </tr> <tr> <td>SLH3S</td> </tr> </tbody> </table> </li> <li>● When acutely-angled abrasion or deformation occurs.                              </li> </ul>	Product No.	D1	B	SLH1N	17mm or more	128mm or more	SLH2N	21mm or more	153mm or more	SLH2S	156mm or more	SLH3N	156mm or more	SLH3S	<ul style="list-style-type: none"> <li>● Overloading</li> <li>● Natural abrasion</li> <li>● Overloading</li> <li>● Unreasonable lifting angle</li> <li>● Natural abrasion</li> <li>● Lack of lubrication</li> <li>● Overloading</li> <li>● Unreasonable lifting angle</li> <li>● Overloading</li> <li>● Natural abrasion</li> </ul>	<p>Disposition</p>
Product No.	D1	B																
SLH1N	17mm or more	128mm or more																
SLH2N	21mm or more	153mm or more																
SLH2S		156mm or more																
SLH3N			156mm or more															
SLH3S																		
<p><b>Shackle (Standard Type)</b></p>	<ul style="list-style-type: none"> <li>● Check for abrasion or deformation of the holes. (by measuring device)</li> <li>● Check for deflection or deformation of the shackle. (by measuring device)</li> </ul>	<ul style="list-style-type: none"> <li>● When the holes are more than designated below in diameter.                              <table border="1" data-bbox="577 1512 976 1639"> <thead> <tr> <th>Product No.</th> <th>D2</th> <th>D3</th> </tr> </thead> <tbody> <tr> <td>SLH1N</td> <td>17mm or more</td> <td>26mm or more</td> </tr> <tr> <td>SLH2N</td> <td rowspan="2">21mm or more</td> <td rowspan="2">34mm or more</td> </tr> <tr> <td>SLH3N</td> </tr> </tbody> </table>  </li> <li>● When the shackle is deformed</li> </ul>	Product No.	D2	D3	SLH1N	17mm or more	26mm or more	SLH2N	21mm or more	34mm or more	SLH3N	<ul style="list-style-type: none"> <li>● Overloading</li> <li>● Natural abrasion</li> <li>● Overloading</li> <li>● Unreasonable lifting angle</li> </ul>	<p>Replacement</p>				
Product No.	D2	D3																
SLH1N	17mm or more	26mm or more																
SLH2N	21mm or more	34mm or more																
SLH3N																		

Items	Inspection method	Limit of use	Major causes of defects	Counter-measures					
<b>Shackle (Swivel Type)</b>	<ul style="list-style-type: none"> <li>● Check for abrasion or deformation of the hole. (by measuring device)</li> <li>● Check for deflection or deformation of the shackle. (by measuring device)</li> </ul>	<ul style="list-style-type: none"> <li>● When the hole is more than designated below in diameter.</li> </ul> <table border="1" data-bbox="654 280 901 376"> <tr> <td>Product No.</td> <td>D4</td> </tr> <tr> <td>SLH2S</td> <td rowspan="2">21mm or more</td> </tr> <tr> <td>SLH3S</td> </tr> </table>  <ul style="list-style-type: none"> <li>● When the shackle is deformed more than designated below.</li> </ul> 	Product No.	D4	SLH2S	21mm or more	SLH3S	<ul style="list-style-type: none"> <li>● Overloading</li> <li>● Natural abrasion</li> <li>● Overloading</li> <li>● Unreasonable lifting angle</li> </ul>	Replacement
Product No.	D4								
SLH2S	21mm or more								
SLH3S									
<b>Swivel (Swivel Type)</b>	<ul style="list-style-type: none"> <li>● Check for abrasion or deformation of the hole. (by measuring device)</li> </ul>	<ul style="list-style-type: none"> <li>● When the swivel is deformed more than designated below.</li> </ul> 	<ul style="list-style-type: none"> <li>● Overloading</li> <li>● Natural abrasion</li> <li>● Unreasonable lifting angle</li> </ul>						
<b>Lever</b>	<ul style="list-style-type: none"> <li>● Check for abrasion or deformation of the hole. (by measuring device)</li> </ul>	<ul style="list-style-type: none"> <li>● When the hole is 9mm or more in diameter.</li> </ul> 	<ul style="list-style-type: none"> <li>● Overloading</li> <li>● Natural abrasion</li> </ul>	Replacement					
<b>Supporting pin and bolt</b>	<ul style="list-style-type: none"> <li>● Check for deflection or deformation. (by visual check or measuring device)</li> </ul>	<ul style="list-style-type: none"> <li>● When the bolt is deformed 0.5mm or more than the standard dimension.</li> </ul> 	<ul style="list-style-type: none"> <li>● Overloading</li> <li>● Natural abrasion</li> </ul>	Replacement					
<b>Spring</b>	<ul style="list-style-type: none"> <li>● Check whether there is proper resilience, when the lever is pressed.</li> </ul>	<ul style="list-style-type: none"> <li>● When proper resilience is not gained due to deformation or other and when the lever is not properly operated.</li> </ul>	<ul style="list-style-type: none"> <li>● Cyclic fatigue</li> </ul>	Replacement					