



# **Structure Clamp**

## **HLC-S**

## **HLC-W**

### **Operation Manual**

This operation manual explains the basic operation and handling of the clamps. Please read this manual carefully before use and observe the precautions for safe operation.

**SUPER TOOL CO., LTD.**



brand lifting clamps are energy-saving lifting equipment which have been developed for the purpose of transporting steel materials.

## **Proper use**

Operate lifting clamps after carefully reading and understanding this instruction manual for enhancing efficiency and safety of operation.

## **Prime efficiency and economy**

Advanced functions, reasonableness and versatile applications of finely and carefully designed  lifting clamps ensure prime efficiency and economy.

## **Special considerations on safety**

We conduct a pulling test with a load three times (or twice) of rated capacity and a manufacturing serial number is marked on each product, thus directing a special attention to safety.

## Precautions for safety operation

(Pages 1~10 are comon to all lifting clamp models)

**Be sure to read this instruction manual carefully before use.**

Mistaken use of lifting clamp may cause a danger such as dropping of load.

Education of “crane safety regulations,” “operation manual for lifting clamp,” “your company’s operation standards,” etc. should be given before actual operation not only to business owners who have purchased clamps but also to their operators to ensure that actual operators have acquired enough knowledge, safety information, and precautions of the clamps.

Safety precautions are divided into two classifications in this manual; “Warning” and “Caution,”.



### **WARNING:**

Indicates a potentially hazardous situation which, if not avoided, could result in death or serious injury.





### **CAUTION:**

Indicates a potentially hazardous situation which, if not avoided, could result in medium damage or slight injury, or could result in property damage.

While only mentioned in  CAUTION, failure to comply with them still may lead to a serious disaster. As such, do not fail to pay attention both to WARNING and CAUTION which are of great importance.

### **Meanings of Signs**

The signs of  and  indicate that precautions should be taken.

The contents of warning or caution are described at each sign.



The sign of  indicates prohibited actions.

The sign of  indicates that an action is enforced or instructed.







Two point lift for  righthand figure.

※ After reading this manual, make sure to keep it at a place of easy access by any users.







# 1. Handling in general

 <b>WARNING</b>	
<ul style="list-style-type: none"> <li>● Do not operate until the contents of the operation manual, and caution tag/plate are thoroughly read and understood.</li> <li>● Do not operate without a legal qualification.</li> <li>● Be sure to clear of the area of the operation for lifting or turning a load against possible drop off or fall over.</li> <li>● Do not use for other than intended purpose.</li> </ul>	 Prohibited
<ul style="list-style-type: none"> <li>● Make sure to execute an inspection periodically and before each operation.</li> </ul>	 Instructed



# 2. Check before operation





 <b>WARNING</b>	
<ul style="list-style-type: none"> <li>● Do not use clamp unsuitable for the operation method.</li> <li>● Do not use clamp of an abnormal condition; deformed, cracked, worn, malfunctioning, etc.</li> <li>● If the load is under the following conditions, do not use clamp. (A material of fragile, high-hardness, low-hardness or extremely low-hardness, or a member with the gripping part tapered down more than 8°)</li> </ul>	 Prohibited
<ul style="list-style-type: none"> <li>● Check the type, rated capacity, clamp range, and “periodic inspection completed” label displayed on clamp body.</li> <li>● The load to be lifted shall be within an allowable range of rated capacity of clamp.</li> <li>● Thickness of load shall be within designated clamping range.</li> </ul>	 Instructed
 <b>CAUTION</b>	
<ul style="list-style-type: none"> <li>● Do not use clamp for the load under the following conditions. (Load to be lifted is more than 150°C, or in an atmosphere or solution of acid or alkaline chemicals less than minus 20°C)</li> </ul>	 Prohibited
<ul style="list-style-type: none"> <li>● Sling to be used for the clamp shall be an appropriate one for lifting operation.</li> </ul>	 Instructed

### 3. Lifting operation





 <b>WARNING</b>	
<ul style="list-style-type: none"> <li>● Do not use clamp, lifting at one point. (excluding special or custom ordered products)</li> <li>● Do not use the clamp in the following ways of lifting: lifting of two or more individual objects at one time. (overlapped loads, padded load etc. , or side gripping)</li> <li>● Do not use the clamp for pulling out steel plate sheet from the steel sheet pile or for vertical lifting of the sheet.</li> <li>● Do not use the clamp when strong wind may threaten to cause any danger.</li> <li>● Do not use the clamp for a hydraulic shovel.</li> </ul>	 Prohibited
<ul style="list-style-type: none"> <li>● Install two or more clamps in a balanced way to keep the balance of load.</li> </ul>	 Two point lift
<ul style="list-style-type: none"> <li>● The lifting angle of the clamps and the dividing angle should be kept within the allowable angles according to types. Load should be inserted to the innermost end of the jaw opening.</li> <li>● When you use the clamp with a lock mechanism, never fail to have the lock engaged.</li> </ul>	 Instructed
 <b>CAUTION</b>	
<ul style="list-style-type: none"> <li>● If oil, paint, scale, rust, etc. are on the gripping pad, do not use the clamp.</li> <li>● Do not drop clamp or drag on the ground.</li> </ul>	 Prohibited

### 4. Operation of a crane

 <b>WARNING</b>	
<ul style="list-style-type: none"> <li>● Never lift a load exceeding the rated capacity.</li> <li>● Do not operate a crane in such a way as to give an impact to the load or the clamp.</li> <li>● Do not allow a person to stand on the load or to carry him.</li> <li>● Do not lift a load which is not free from any other objects.</li> <li>● Do not release the lock of clamp while lifting load.</li> <li>● Avoid unintended contact by load to an adjacent member or to the clamp, which has been removed from the load.</li> </ul>	 Prohibited

<ul style="list-style-type: none"> <li>● Stop the lifting operation by crane for a moment when the load is applied to the lifting ring for safety checking. (depth of the load into the clamp opening; status of locking).</li> <li>● Stop the operation of the crane just before the load reaches the ground, and check the following matters: (Inclination or falling over of the load and security around the landing area of the load)</li> </ul>	 Instructed
 <b>CAUTION</b>	
<ul style="list-style-type: none"> <li>● Do not operate the crane in such a way as to drag the load along the ground.</li> <li>● Do not leave the crane (or winder, etc.) unattended from an operating position while keeping the load lifted with the clamp.</li> </ul>	 Prohibited
<ul style="list-style-type: none"> <li>● Raising and lowering operation by crane should be done slowly and carefully.</li> </ul>	 Instructed

## 5. Maintenance, storage and alteration

 <b>WARNING</b>	
<ul style="list-style-type: none"> <li>● Never alter the clamp and its accessories.</li> <li>● Do not apply welding or heat to the clamp or its accessories.</li> <li>● Do not use any other parts than our company's genuine parts.</li> <li>● Clamps which require the repair should be stored at a different place so that they are not used mistakenly.</li> </ul>	 Prohibited
<ul style="list-style-type: none"> <li>● Persons with specialized knowledge designated by the business owner are to conduct maintenance and repairing work.</li> <li>● When any abnormality with the clamp is found, do not use it and immediately repair or dispose.</li> <li>● Remove, if any, paint or mud sticking to the moving parts of the clamp, cams, and pads.</li> </ul>	 Instructed
 <b>CAUTION</b>	
<ul style="list-style-type: none"> <li>● Conduct maintenance and repairing without any load attached.</li> <li>● Conduct maintenance and repairing after posting a sign indicating that you're on the maintenance work.</li> <li>● Never fail to lubricate oil on the rotating parts of the clamp (around the pins), guide grooves, sliding parts, etc.</li> <li>● Be sure to store clamps indoor.</li> </ul>	 Instructed

## ■ General warning for use (comon to all lifting clamp models)

1. Be sure to select proper model clamps for use.  
**Pay special attentions to keep the lifting direction (rope angle).**
2. Confirm the weight of the load. Do not exceed maximum capacity (designated ton) on clamps. (Never overload.)
3. Before use, confirm followings:
  - (a) Proper capacity of clamps.
  - (b) No abnormal movements of clamp or loosening of any bolts.
  - (c) No oil or other foreign matters on the surface of the cam and pad.
4. **Never use for load beyond the clamp range.**
5. When installing clamps, insert a lifting load completely until it comes in contact with the deepest of the jaw opening of main body.
6. **Depending on the model or capacity of the clamp, the cam teeth may not bite a load sufficiently when the load is a hard or light weight material (Less than 1/5 of maximum capacity or less than 1/4 of maximum clamp range). Confirm the condition of clamp for safety.**
7. Confirm that the safety lock is completely engaged in case clamp has a built-in lock.
8. Confirm that the load is well balanced. Determine the clamp position or the center of gravity of the rope properly. It is especially important to determine the horizontal center of gravity.
9. When lifting at 2 points, be sure to use two wire ropes, and make them equal length. (Fig. A)

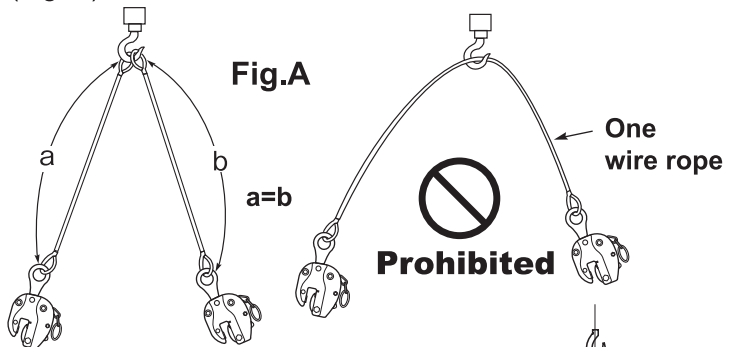

10. When lifting at 2 points, keep the lifting angle within 60°. (Fig. B)  
(Follow the standards if lifting angle is specified depending on items.) If the load is long, use a balance.

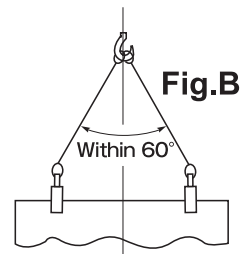

11. Never lift two or more steel plates or steel members at a time.
12. The load may move to an unexpected direction when lifted off the ground and as such confirm the center of gravity and the clamping position for safety when raising. Sufficient caution should be taken until the clamp with the load becomes completely balanced.
13. When changing directions of the load or any similar operations, all personnel must be clear of the area of operation. (Fig. C)

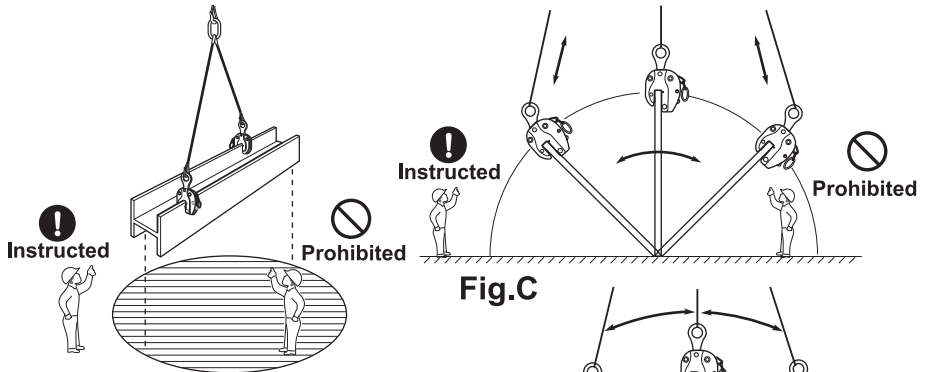

**Fig.C**

14. Do not ride on the lifting load. Never use clamp for riding or carrying person.
15. Keep momentary inverting angle of a steel plate within 30°. (Fig. D)

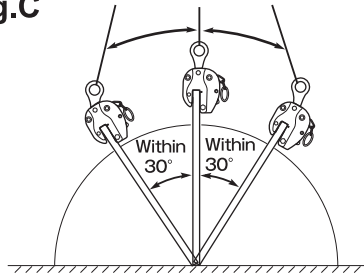

**Fig.D**

16. **Before operation, the surface of load must always be clean and free of scale, coatings or other foreign matters that will reduce clamping force significantly.**
17. **When raising, special attention must be given to prevent the rope from loosening by its unintended contact with any other objects.**
18. When raising again after the load is put on ground, reconfirm the clamp condition.
19. Do not use clamp for heated load or in a corrosion liquid because safety factor and durability will be reduced in such conditions.
20. Do not alter clamp by welding, cutting by gas or by any other modification.
21. Do not weld electrically a load while being lifted by clamp.
22. Conduct daily maintenance and lubrication.



## ■ Maintenance and Inspection

### 1. Maintenance

Daily maintenance is important for efficient and safe operation even under the severe use condition and for such purposes, please comply with the followings.

- (1) Designate the use standards and control.
- (2) Keep clamps indoor and do not leave them outdoor.
- (3) Check the followings to maintain in a good condition.
  - (a) Operating condition.
  - (b) Any abrasion, damage, or clogging at teeth of cam and pad.
  - (c) Deformation of main body - at jaw opening in particular.
- (4) Separate conforming clamps and other hazardous items identified during use or inspection and designate the defective sections. Perform maintenance any soon.
- (5) For the storage, place soft material as wooden chip in-between cam and pad to protect the teeth.
- (6) Perform inspection and maintenance once a week by referring to "Inspection Standards". Lubricate sliding sections periodically. (However, remove oil at teeth of cam and pad.)

### 2. Periodic Inspection

Perform periodic inspection in accordance with the periodic inspection and maintenance standards. Functions and life of clamps may differ in a great degree as they are used in varieties of fields under different conditions of use. Therefore, preparation and practice of effective handling/inspection standards manual by users themselves are recommended. We ask you to establish complete maintenance and control for assurance of safety in reference to our Manufacturer's Inspection Standards of our clamp. Clamp is designed for easy replacement of parts and therefore, do not fail to replace defective parts. Also, keeping spare parts at all times is recommended. For your preparation of the standards, pay special attention to the followings.

- (1) Operation and maintenance standards
  - (a) Preparation of use criteria (shape of load and operating methods).
  - (b) Thorough understanding and compliance of cautions on handling.
  - (c) Maintenance and storage.
  - (d) Rules of inspection and check at site.

- (2) Standards on periodic inspection
  - (A) Establishing dates of periodic inspection.
  - (B) Establishing inspection and maintenance methods.
    - (a) Inspecting period.
    - (b) Person in charge of the inspection.
    - (c) Inspection site.
    - (d) Tools and devices for inspection.
    - (e) Establishment of permissible limit of use.
    - (f) Explicit designation of maintenance and repair methods.

### **3. Manufacturer's inspection method**

Our company's inspection procedures are as follow.

Check for



- (1) Movements.
- (2) Wear, loss, and/or clogging of/at the teeth of the cam and screw.
- (3) Deformation of main body.
- (4) Deformation of shackle.
- (5) The status of bolts, pins, links and springs.
- (6) Deep scratches in general.
- (7) Other checking items based on the Standards.

## Lifting angle and rated load of wire rope

The maximum rated capacity of wire ropes also differs according to the lifting angle.  
Therefore, after paying attention to the lifting angle, always use wire ropes with the appropriate diameter.

### Correlation table between the lifting angle and the applicable load for wire rope (for 2-point lifting)

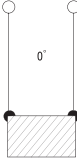
■ JIS G 3525 6×24 A type

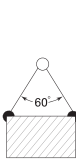
D wire rope diameter  (mm)	W rated load (for 1 single rope) [ Safety factor S=6 ]  (ton)			
		(Change in % of the lifting capacity rate according to the lifting angle)		
		100%	96%	86%
		Maximum allowable load (rated load) for 2 wire ropes (ton)		
6	0.30	0.60	0.57	0.51
8	0.53	1.07	1.03	0.92
9	0.67	1.35	1.30	1.16
10	0.83	1.67	1.61	1.44
12	1.20	2.41	2.32	2.08
14	1.64	3.28	3.15	2.83
16	2.14	4.28	4.12	3.69
18	2.72	5.44	5.23	4.69
20	3.35	6.70	6.44	5.77
22	4.06	8.12	7.81	7.00
24	4.82	9.65	9.28	8.32
26	5.66	11.3	10.8	9.76
28	6.58	13.1	12.6	11.3
30	7.55	15.1	14.5	13.0
32	8.58	17.1	16.5	14.8
36	10.8	21.7	20.8	18.7
40	13.4	26.8	25.8	23.1

### Calculation formula of a wire rope diameter and rated load (for 1 single rope)

\* Refer to the calculated values as rough indications.

$$① D = \sqrt{W \times C}$$

$$② W = \frac{D^2}{C}$$

D= wire rope dia. (mm)  
W= rated load (ton)  
C= 120 (constant)  
(with Safety factor S = 6)

★ When looking for the required wire rope diameter to lift a 3 ton load

$$① D = \sqrt{W \times C}$$

$$D = \sqrt{3 \times 120} = \sqrt{360} = 19 \rightarrow$$

**20mm**

★ When looking for the maximum capacity (rated load) of a wire rope with 12mm diameter

$$② W = \frac{D^2}{C}$$

$$W = \frac{12^2}{120} = \frac{144}{120} = 1.2 \rightarrow$$

**1.2ton**



# Structure Clamp

## HLC-S

## HLC-W

Operation Manual and Inspection Standards



# Structure Clamp

## HLC-S HLC-W

### Operation method

1. Remove iron powder, sand, oil, stone or other harmful deposits on an object to be lifted, cam and pad of body.
2. Insert object to be lifted by pushing down a shackle part of cam until the object to be lifted touches end of slot.
3. Clamp the object to be lifted so that the surface of pad will become parallel against the bottom face of object to be lifted.
4. When detaching object to be lifted, push down the head of cam by hand or with hammer towards the direction of cam-opening.

### Warning:

Do not push down the head of cam until the object to be lifted is at rest.

# Replacement parts and fittings (Model: HLC-S, HLC1W)

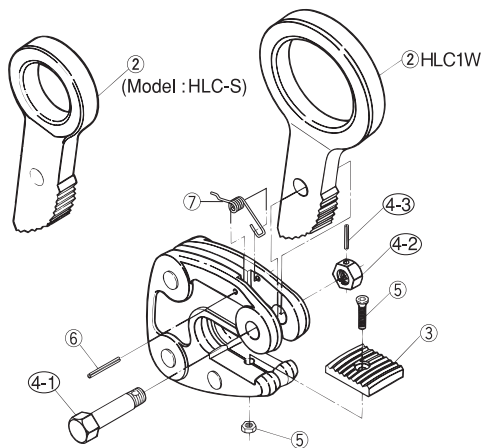

No.	Part Name	Item No.
②	Cam (Model:HLC1W)	HLCT1W
②	Cam (Model:HLC-S)	HLCT-S
CAM SUPPORT BOLT ASSEMBLY		HLK
4-1	Support bolt for cam	HLCK
4-2	Support nut for cam	
4-3	Spring pin	
PAD (New Type) ASSEMBLY		HLA
③	Pad	HLCA
⑤	Bolt and nut for pad	HLCD
PAD (Old Type) ASSEMBLY		HLP
③	Pad	HLCP
⑤	Bolt and nut for pad	HLCN
SPRING ASSEMBLY		HLS
⑦	Spring	HLCS
⑥	Spring pin	HLCCQ

## Replacement procedure for cam and pad

### Disassembling and Reassembling of Cam

Pull out spring pin in nut side, and remove bolt and nut.

Then the cam is detached. Reassemble in the reverse order. (In this case, do not remove the spring pin for spring.)

### Disassembling and Reassembling of Pad

Remove bolt and nut with socket wrench and hexagon wrench key, then pad may be easily disassembled or reassembled.

### HLC-S HLC1W



HLC0.5S

HLC-S

HLC1W

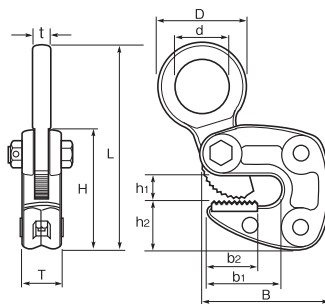

Dimension in mm

ITEM No.	Capacity (tons)	Clamping range	L	t	T	H	h1	h2	B	b1	b2	D	d	Weight (kg)
HLC0.5S	0.5	1~13	139	14	31	97.5	25.5	34.5	100	65	43	46	23	1.3
HLC1S	1	1~13	152	14	32	104	23.5	39	108	66	44	51	23	1.5
HLC2S	2	3~22	199	18	42	136	36	49	142	87	58	56	30	3.7
HLC3S	3	12~35	263	22	48	179	41.5	69	184	108	68	80	36	8.1
HLC1W	1	2~20	188	14	32	118	31.5	42.5	123	75	47	72	46	2.5

## ■ CAUTION:

- ◆ Use within the rated capacity.
- ◆ Use within the clamp range.
- ◆ Do not use for any objects other than steel materials.
- ◆ Do not use for hard (30 HRC or higher) load.
- ◆ Lifting is not allowed for a load tapering down in upward direction.
- ◆ Do not apply shock to the load or lifting clamp.
- ◆ Do not lift more than one plate.
- ◆ Before using the product, be sure to check for clogging and wear of the teeth of the cam, screw and any other parts.
- ◆ Do not alter. Heating, modifying, etc. will significantly reduce the quality (strength).

## ■ OTHER:

- ◆ Inquiries for Repair Parts and Repair.  
If repair parts or repairs are required, stop using this clamp and contact your distributor.

## ■ DAILY INSPECTION:

Conduct daily checks and maintenance to prevent the loss of safety and efficiency.

1. Check that there are no cracks at the body, cam, or wire rope holes.
2. Check if the movement and lubrication condition of each part are good.
3. **Check for wear, loss, or clogging of the teeth of the cam and screw.**
4. Refer to other inspection standards.

# Standards for checking clamps (Model:HLC-S·HLC1W)

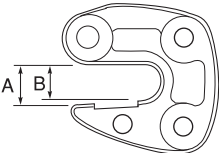
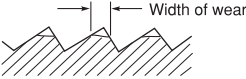
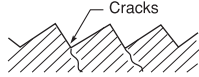
SECTION	INSPECTING METHOD	PERMISSIBLE LIMIT	CAUSES OF THE TROUBLE							
<b>Body</b>	<p>Visually check or use color dyes to locate cracks.</p> <p>Measure the jaw opening.</p> <p>Visually check and measure each section for deformation.</p>	<p>Dispose of the clamp when a crack is found.</p> <p>Dispose of the clamp when the difference of “A” and “B” exceeds 5%. More than 5mm for 100mm difference.</p> 	<ul style="list-style-type: none"> <li>* Overloading</li> <li>* Dynamic loads</li> <li>* Too large hoisting angle</li> </ul> <ul style="list-style-type: none"> <li>* Overloading</li> <li>* Dynamic loads</li> <li>* Too large hoisting angle</li> </ul> <ul style="list-style-type: none"> <li>* Overloading</li> <li>* Too large hoisting angle</li> </ul>							
<b>Cam and Pad</b>	<p>Visually check and measure the amount of wear.</p> <p>Visually check and use color dyes to locate cracks at the base of the cam teeth.</p>	<p>Replace when the width of wear exceeds the the following limits.</p>  <table border="1" style="margin-left: auto; margin-right: auto;"> <thead> <tr> <th style="text-align: left;">Capacity</th> <th style="text-align: left;">Permissible limit of width of wear</th> </tr> </thead> <tbody> <tr> <td>0.5T</td> <td rowspan="4" style="text-align: center; vertical-align: middle;">under 0.5mm</td> </tr> <tr> <td>1T</td> </tr> <tr> <td>2T</td> </tr> <tr> <td>3T</td> </tr> </tbody> </table> <p>Replace when the cracks are found.</p> 	Capacity	Permissible limit of width of wear	0.5T	under 0.5mm	1T	2T	3T	<ul style="list-style-type: none"> <li>* Natural wear from use</li> <li>* Wear from clamping hard material</li> </ul> <ul style="list-style-type: none"> <li>* Overloading</li> <li>* Dynamic loads</li> <li>* Damage from clamping hard material</li> </ul>
Capacity	Permissible limit of width of wear									
0.5T	under 0.5mm									
1T										
2T										
3T										

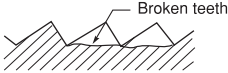
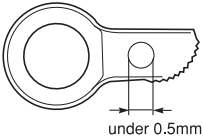
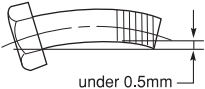

SECTION	INSPECTING METHOD	PERMISSIBLE LIMIT	CAUSES OF THE TROUBLE
Cam and Pad	Visually check for broken cam teeth.	Replace when a cam tooth is broken. 	* Overloading * Dynamic loads * Broken from clamping hard material
	Measure the bolt hole for wear.	Replace when the wear and the deformation exceeds 0,5mm. 	* Overloading * Wear from repeated use * Insufficient lubrication
Cam Support Bolt	Measure the shaft section of the bolt and check for wear.	Replace when the clearance between the shaft and the hole exceeds 1mm, and the swing of cam becomes bigger.	* Wear from repeated use * Insufficient lubrication
	Visually check and measure the amount of deformation and bends.	Replace when the deformation exceeds 0.5mm. 	* Overloading * Dynamic loads
Springs	Confirm that the spring generates a constant initial load when the cam is closed.	Replace when deformation or other causes lower the spring below a level that can smoothly move the cam.	* Fatigue caused by repeated use
	Confirm that there is sufficient spring force when the cam is pressed in (to maximum jaw opening).	Replace when deformation or other causes lower the spring force below a level that can smoothly move the cam and safety lever.	* Fatigue caused by repeated use



