

SAFETY LIFTING CLAMPS

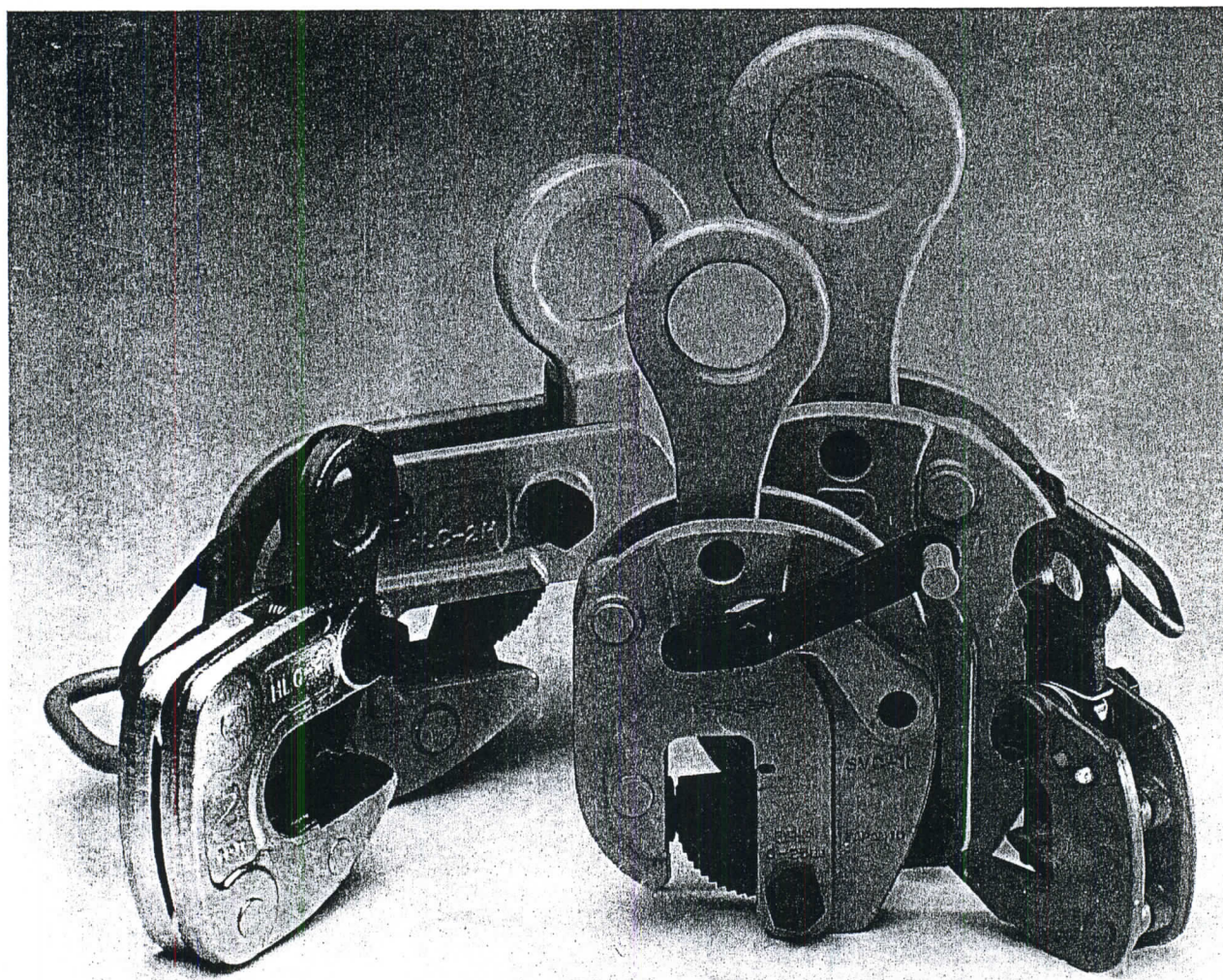

INSTRUCTION FOR OPERATION OF "SUPER" BRAND LIFTING CLAMPS

HLC-U



SUPER TOOL CO., LTD.

OSAKA, JAPAN

WARNINGS (Supplements)

- Never use a steel lifting clamp (hereafter called clamp) on material other than steel!
- When operating clamps, always maintain a firm footing and only operate from a location that will be safe at all times!
- Before lifting the load, confirm that clamps are in good condition and functioning properly!
- Always protect the surface of cam and pad from weld spatters or other damaging contaminants! The surface of the load must always be clean and free of scale, grease, paint, dirt and coating or other foreign matters that can reduce friction!
- Note that the service life of clamps is reduced considerably when stainless steel sheets or high-tensile steel are clamped! Do not use clamps for lifting high-tensile steel (over 300HB) or soft steel (under 80HB)!
- Never vertically lift material that tapers down to the edge!
- Never vertically lift with horizontal or lateral clamps!
- Never lift more than one steel plate at a time!
- Always use slings correctly! Pay special attention to the correlation between the lifting angle and the rated load!
- Never operate clamps unless the load is properly centered!
- After the load has been lifted a few centimeters, confirm that the load is well balanced!
- Never allow the operator's attention to be diverted when operating clamps and never leave the suspended load unattended!
- Never modify clamps!
- Only use genuine parts when repairing clamps!
- Please refer, also, to the warnings in the catalog.

INSTRUCTIONS FOR USE

Keep these instructions within easy access of operators.

It is important that operators understand these warnings and instructions before using.

WARNINGS

- Select proper size clamp for the job. Determine the weight of the plate to be lifted. Do not exceed limited working load shown on clamp.
- Plate thickness must be within grip range shown on clamp. There is a case that the grip of clamp becomes insufficient in lifting hardened plate and light weight plate (less than 1/4 of maximum grip size of clamp in the thickness or less than 1/5 of limited working load of clamp in the weight). Use clamp after confirmed the gripped state.
- Inspect clamp. If cam or pad teeth are worn, or if clamp is damaged, do not use.
- All personnel must stand clear of load while it is being lifted or moved.
- Take up slack slowly. Do not bounce or jerk load.
- Use clamp with correct manners after read following illustration for lifting and clamping manners.

CORRECT MANNER OF USE

Lift at least at two points. +

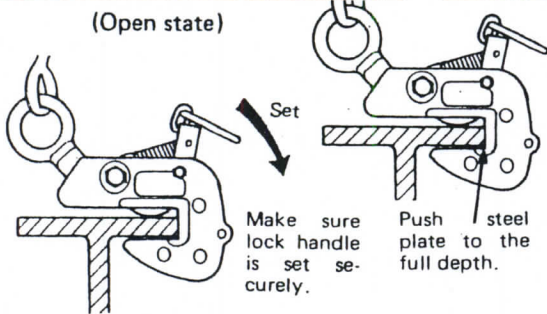

Do not lift yet in this state.

Tightening is complete. Now ready to lift.

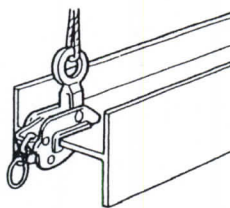

Safety lock is applied, and the clamp is firm.

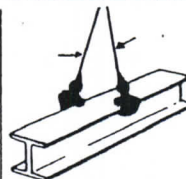

When clamping and lifting at the position of center of gravity of steel plate, hold at two points as shown here.

(At this time, keep the wire angle within 30°.)

Chucking direction and lifting method of section steels
H, I section H, I section T section

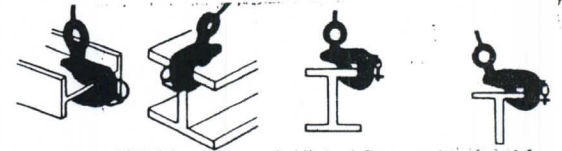

✘ WRONG MANNERS...DANGEROUS!

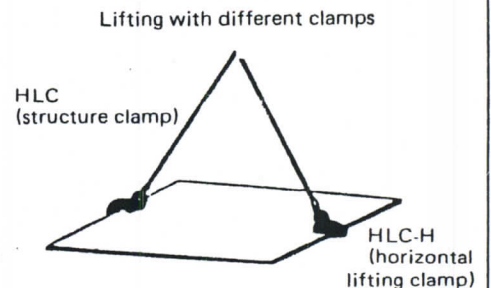
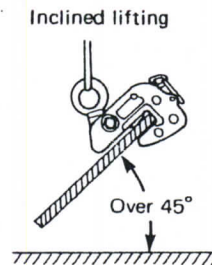
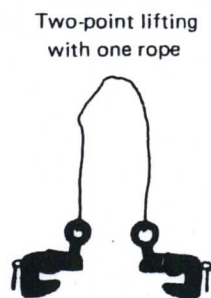
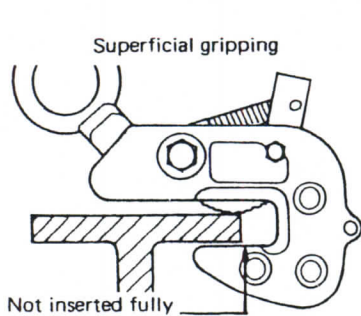

Lifting of extremely curved steel plate or end plate



Lifting plural plates at two points



One side lifting

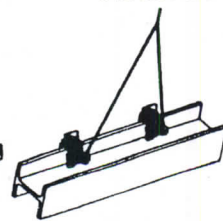

Exceeding the specified angle

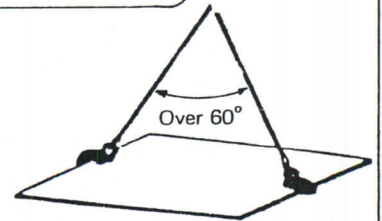
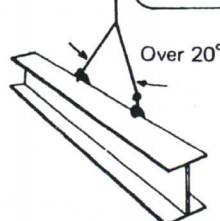

Other Cautions • Do not lift object exceeding the clamping range. • Do not weld electricity the plate being lifted by clamps.

"SUPER" CLAMPS Maintenance and Repair

Check periodically, repair and replace parts, and use correctly in order to use the clamps over the full service life, safely.

Common Check Points

- ★ Check the main body for distortion or flaw.
- ★ Make sure the opening is normal (check if widened).
- ★ Check if the shackle is distorted.
- ★ Check the shackle pin hole for widening or looseness.
- ★ Check cam and pad teeth for defect or wear.
- ★ Check cam pin hole in main body for widening.
- ★ Check if cam pin is worn and thinned.
- ★ Check the performance of tightening lock (handle, lever), shackle, and other mechanism.

Check all the listed items. Inspect according to the Checking Standard.

Most items may be checked visually or by touching. To measure the safety point distance and opening size, use slide calipers or the like to obtain precise measurements.

DISCARD

When clearance between bolt and hole exceeds 1 mm, and deflection of cam or shackle becomes excessive.

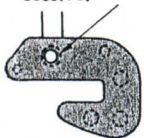

(Wear of pin or pin hole)



(Flaw of main body)

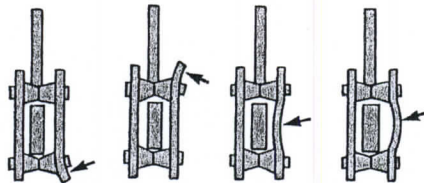

(Distortion of main body)

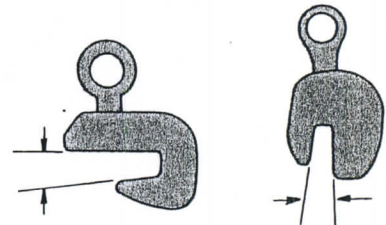

(Widening of opening)

Discard the clamp if obvious flaw or distortion is found in the main body. Defects in the main body cannot be repaired in the light of safety. The main body may be cracked or deformed only after several uses if it is used incorrectly. Dent or swelling of main body, or widening of opening may be caused by overload or wrong manner of use. If the defect is repaired by welding, hardening, or pressing, the original strength is not recovered. When used and controlled correctly, the clamp may be safely used for a long time only by replacing parts.

REPLACE

(Shackle)

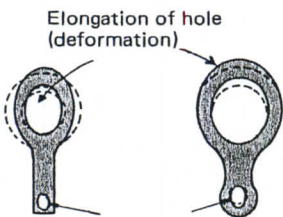

Elongation of hole (deformation)

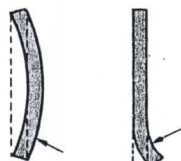

Distortion (deformation)

Regard the shackle as part of body. If deformed as shown above, replace it immediately. If deformed shackle is straightening up, the initial strength is not restored.

(Cam and pad)

Clamping capacity	Wear limit width of cam, pad
0.5 ton	0.6mm or more
1 ton	0.7mm or more
2 tons	0.8mm or more
3 tons	0.9mm or more
5 tons	1.0mm or more

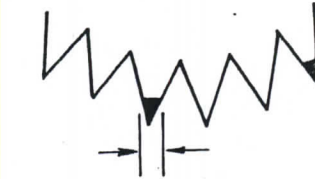

When worn as shown above, replace immediately. Or, if not worn, when even one tooth is missing, replace also immediately. The wear rate is accelerated when stainless steel or other hard material is clamped. Or when plates of specified thickness are continuously clamped, only particular threads will be worn in a short time. In such a case, too, replace immediately.

Besides, replace the support pins, bolts, springs, and other parts according to the Checking Standard.

Check Twice to Confirm Safety.

Check the type capacity of clamp. Is the wire rope proper? How about its size and length? Overloaded or not? Where's the center of gravity? Is the material inserted fully? Is it locked securely? Lift at two points for an object longer than a meter. Lift at three or four points where the center of gravity is hard to locate. Is the lifting angle proper? Check all these items, and confirm them once again. Lift, carry, touch down slowly. Be careful not to hit against surrounding objects while carrying. Keep off hands. Do not enter hazardous zone. Always pay attention to safety.

LIFTING ANGLE AND SAFE LOAD OF WIRE ROPE

The maximum allowable load ((safe load)) of wire rope also varies with the lifting angle. Therefore, select a wire rope of proper diameter in consideration of the lifting angle. ((The breakage load specified in the table below refers to No.4, 6 x 24A class of JIS G 3525.))

Correlation between Lifting Angle and Safe Load of Wire Rope (in two-point lifting)

D Wire rope dia (mm)	σ Breakage load (tons)	W Safe load (on one rope) W=σ/S (safety factor S=6) (tons)						
			(Changes in lifting efficiency due to lifting angle, %)					
			100%	96%	92%	86%	70%	50%
Max. allowable load (safe load) on two wire ropes (tons)								
8	3.21	0.54	1.08	1.04	0.99	0.93	0.76	0.54
9	4.06	0.68	1.36	1.31	1.25	1.17	0.95	0.68
10	5.02	0.84	1.68	1.61	1.55	1.44	1.18	0.84
11.2	6.29	1.05	2.1	2.02	1.93	1.81	1.47	1.05
12.5	7.84	1.31	2.62	2.52	2.41	2.25	1.83	1.31
14	9.83	1.64	3.28	3.15	3.02	2.82	2.3	1.64
16	12.8	2.13	4.26	4.09	3.92	3.66	2.98	2.13
18	16.2	2.7	5.4	5.18	4.97	4.64	3.78	2.7
20	20.1	3.35	6.7	6.43	6.16	5.76	4.69	3.35
22.4	25.2	4.2	8.4	8.06	7.73	7.22	5.88	4.2
25	31.3	5.22	10.44	10.02	9.6	8.98	7.31	5.22
28	39.3	6.55	13.1	12.58	12.05	11.27	9.17	6.55
30	45.1	7.52	15.04	14.44	13.84	12.93	10.53	7.52
31.5	49.8	8.3	16.6	15.94	15.27	14.28	11.62	8.3
33.5	56.3	9.38	18.76	18.01	17.26	16.13	13.13	9.38
35.5	63.2	10.53	21.06	20.22	19.38	18.11	14.74	10.53

Note: For four-point lifting, multiply the corresponding figure in the table by 2 to find the maximum allowable load (safe load).

Simplified calculation method of wire rope diameter and safe load (one-point lifting)

1) $D = \sqrt{W \times C}$

2) $W = \frac{D^2}{C}$

Where D : wire rope diameter(mm)
 W : safe load (tons)
 C : constant=120
 (safety factor S=6)

★ To find the diameter of wire rope for 3 tons:

① $D = \sqrt{W \times C}$

$D = \sqrt{3 \times 120} = \sqrt{360} = 19 \rightarrow 20 \text{ mm}$

★ To find the service load (safe load) on 25mm diameter wire rope:

② $W = \frac{D^2}{C}$

$W = \frac{25^2}{120} = \frac{625}{120} = 5.2 \rightarrow 5.2 \text{ ton}$

Replacement parts and fittings (Model : HLC-U)

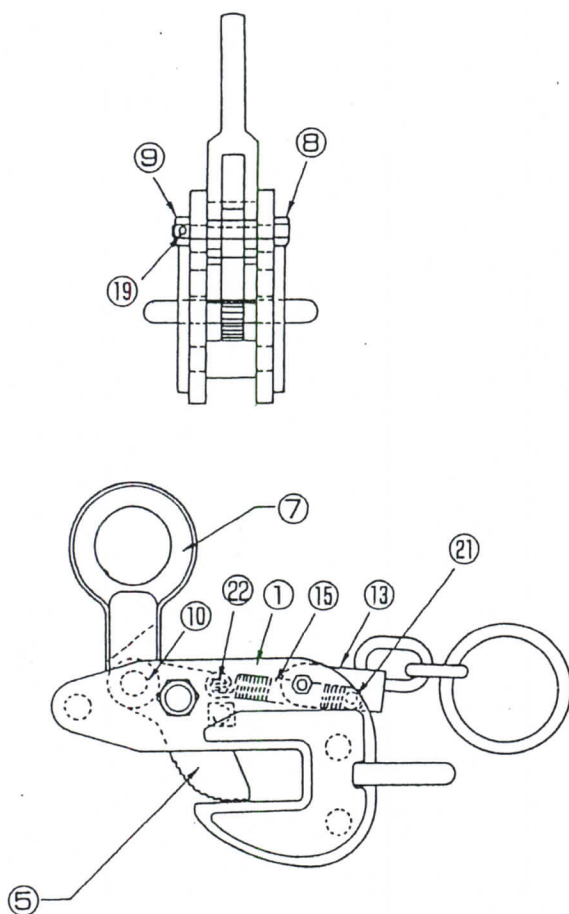

Part No.	Part Name	Item No.
SHACKLE ASSEMBLY		HLH
7	Shackle	HLCH
10	Support pin for shackle	HLCY
CAM ASSEMBLY		HLT
5	Cam	HLCT
22	Spring pin	HLCR
8	Support bolt for cam	HLCN
9	Support nut for cam	HLCO
19	Spring pin	HLCO
HANDLE ASSEMBLY		HLU
13	U-handle	HLCU
16	Hex. socket flat head bolt	HLCK
17	U-nut	HLCC
18	Collar	HLCQ
21	Spring pin	HLCQ
15	Spring	HLCS

Replacement procedure for cam and pad

Diassembling

CAM

Take out Cam support bolt (8) by loosening Cam support nut (9) after pulled out Spring pin (19) of Nut (9). Then, remove Shackle (7) and Cam (5) from body and take out Spring pin (22) for Spring (15) after removed Shackle pin (10).

Reassembling

CAM

Reassemble in the reverse order after inserted new Cam to the position correctly.

Lateral Lifting Clamps, (Splitted Jaw Type)

Model : HLC-U

Operation method

1. Insert onto steel plate (object to be lifted) sufficiently deeper than red mark on the mouth part of body.
2. Lower tension arm into lower position as shown in the right drawing.
3. When detaching plate, release the locked state with the lock handle as shown after loosed the wire rope.
Warning : Do not reverse spring tension untill plate is at rest.
4. Do not lift steel plate in the state of 1 and 3.

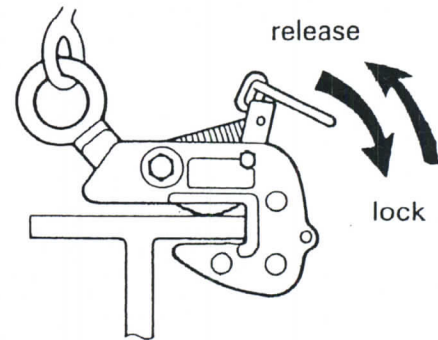

LATERAL LIFTING CLAMPS

Splitted Jaw Type

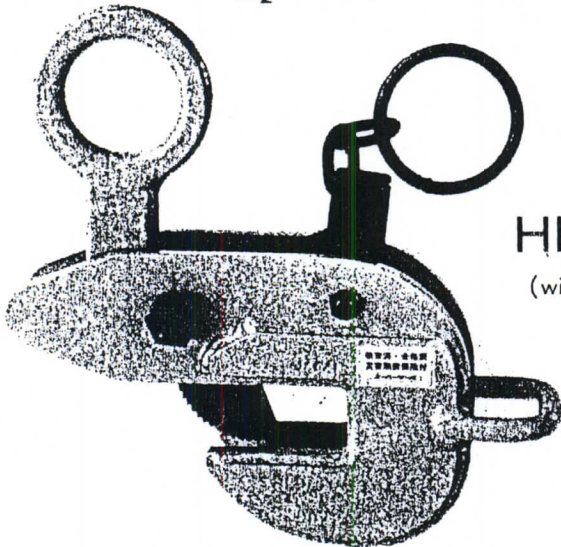

HLC-U
(with tightening lock)

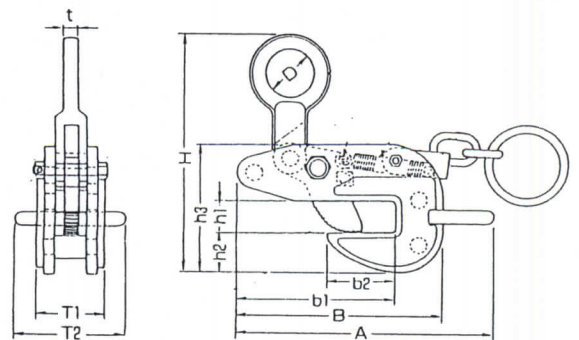

Dimension Table

Dimensions in mm

ITEM NO.	Cap, ton	Clamping, Weight Range (Kgs.)	H MAX	h1	h2	h3	A	B	b1	b2	D	T1	T2	t
HLC-0.5U	0.5	0-25	3.2	208	28	35	212	170	130	56	40	57	84	12
HLC-1U	1	0-30	5.1	246	33	46	250	208	152	65	50	64	84	16
HLC-2U	2	0-35	8.7	292	38	58	283	241	173	74	60	80	98	18
HLC-3U	3	0-40	13.5	337	43	70	329	273	193	83	70	90	112	20
HLC-5U	5	0-45	21.5	385	48	86	370	314	218	90	80	102	112	22