



Vertical Lifting Clamp

(Lock Handle type with Universal shackle)

SVC-E

Operation Manual

This operation manual explains the basic operation and handling of the clamps. Please read this manual carefully before use and observe the precautions for safe operation.

SUPER TOOL CO., LTD.

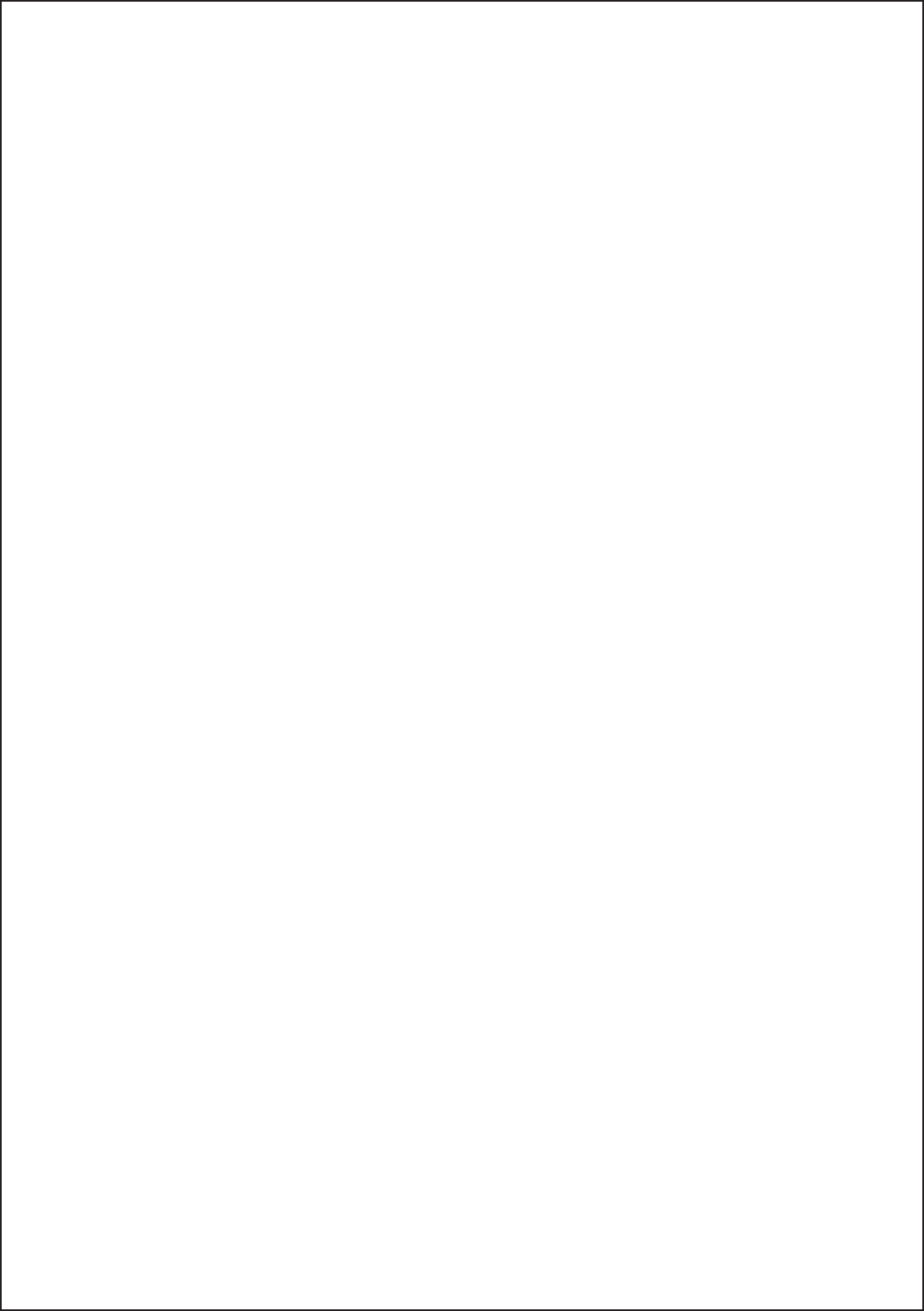



brand lifting clamps are energy-saving lifting equipment which have been developed for the purpose of transporting steel materials.

Proper use

Operate lifting clamps after carefully reading and understanding this instruction manual for enhancing efficiency and safety of operation.

Prime efficiency and economy

Advanced functions, reasonableness and versatile applications of finely and carefully designed  lifting clamps ensure prime efficiency and economy.

Special considerations on safety

We conduct a pulling test with a load three times (or twice) of rated capacity and a manufacturing serial number is marked on each product, thus directing a special attention to safety.

Precautions for safety operation

(Pages 1~10 are common to all lifting clamp models)

Be sure to read this instruction manual carefully before use.

Mistaken use of lifting clamp may cause a danger such as dropping of load.

Education of “crane safety regulations,” “operation manual for lifting clamp,” “your company’s operation standards,” etc. should be given before actual operation not only to business owners who have purchased clamps but also to their operators to ensure that actual operators have acquired enough knowledge, safety information, and precautions of the clamps.

Safety precautions are divided into two classifications in this manual; “Warning” and “Caution,”.



WARNING:

Indicates a potentially hazardous situation which, if not avoided, could result in death or serious injury.





CAUTION:

Indicates a potentially hazardous situation which, if not avoided, could result in medium damage or slight injury, or could result in property damage.

While only mentioned in  CAUTION, failure to comply with them still may lead to a serious disaster. As such, do not fail to pay attention both to WARNING and CAUTION which are of great importance.

Meanings of Signs

The signs of  and  indicate that precautions should be taken.

The contents of warning or caution are described at each sign.



The sign of  indicates prohibited actions.

The sign of  indicates that an action is enforced or instructed.







Two point lift for  righthand figure.

※ After reading this manual, make sure to keep it at a place of easy access by any users.







1. Handling in general

 WARNING	
<ul style="list-style-type: none"> ● Do not operate until the contents of the operation manual, and caution tag/plate are thoroughly read and understood. ● Do not operate without a legal qualification. ● Be sure to clear of the area of the operation for lifting or turning a load against possible drop off or fall over. ● Do not use for other than intended purpose. 	 Prohibited
<ul style="list-style-type: none"> ● Make sure to execute an inspection periodically and before each operation. 	 Instructed



2. Check before operation

 WARNING	
<ul style="list-style-type: none"> ● Do not use clamp unsuitable for the operation method. ● Do not use clamp of an abnormal condition; deformed, cracked, worn, malfunctioning, etc. ● If the load is under the following conditions, do not use clamp. (A material of fragile, high-hardness, low-hardness or extremely low-hardness, or a member with the gripping part tapered down more than 8°) 	 Prohibited
<ul style="list-style-type: none"> ● Check the type, rated capacity, clamp range, and “periodic inspection completed” label displayed on clamp body. ● The load to be lifted shall be within an allowable range of rated capacity of clamp. ● Thickness of load shall be within designated clamping range. 	 Instructed
 CAUTION	
<ul style="list-style-type: none"> ● Do not use clamp for the load under the following conditions. (Load to be lifted is more than 150°C, or in an atmosphere or solution of acid or alkaline chemicals less than minus 20°C) 	 Prohibited
<ul style="list-style-type: none"> ● Sling to be used for the clamp shall be an appropriate one for lifting operation. 	 Instructed

3. Lifting operation



 WARNING	
<ul style="list-style-type: none"> ● Do not use clamp, lifting at one point. (excluding special or custom ordered products) ● Do not use the clamp in the following ways of lifting: lifting of two or more individual objects at one time. (overlapped loads, padded load etc. , or side gripping) ● Do not use the clamp for pulling out steel plate sheet from the steel sheet pile or for vertical lifting of the sheet. ● Do not use the clamp when strong wind may threaten to cause any danger. ● Do not use the clamp for a hydraulic shovel. 	 Prohibited
<ul style="list-style-type: none"> ● Install two or more clamps in a balanced way to keep the balance of load. 	 Two point lift
<ul style="list-style-type: none"> ● The lifting angle of the clamps and the dividing angle should be kept within the allowable angles according to types. Load should be inserted to the innermost end of the jaw opening. ● When you use the clamp with a lock mechanism, never fail to have the lock engaged. 	 Instructed
 CAUTION	
<ul style="list-style-type: none"> ● If oil, paint, scale, rust, etc. are on the gripping pad, do not use the clamp. ● Do not drop clamp or drag on the ground. 	 Prohibited

4. Operation of a crane

 WARNING	
<ul style="list-style-type: none"> ● Never lift a load exceeding the rated capacity. ● Do not operate a crane in such a way as to give an impact to the load or the clamp. ● Do not allow a person to stand on the load or to carry him. ● Do not lift a load which is not free from any other objects. ● Do not release the lock of clamp while lifting load. ● Avoid unintended contact by load to an adjacent member or to the clamp, which has been removed from the load. 	 Prohibited



<ul style="list-style-type: none"> ● Stop the lifting operation by crane for a moment when the load is applied to the lifting ring for safety checking. (depth of the load into the clamp opening; status of locking). ● Stop the operation of the crane just before the load reaches the ground, and check the following matters: (Inclination or falling over of the load and security around the landing area of the load) 	 <p>Instructed</p>
---	--

 **CAUTION**

<ul style="list-style-type: none"> ● Do not operate the crane in such a way as to drag the load along the ground. ● Do not leave the crane (or winder, etc.) unattended from an operating position while keeping the load lifted with the clamp. 	 <p>Prohibited</p>
<ul style="list-style-type: none"> ● Raising and lowering operation by crane should be done slowly and carefully. 	 <p>Instructed</p>

5. Maintenance, storage and alteration

 **WARNING**

<ul style="list-style-type: none"> ● Never alter the clamp and its accessories. ● Do not apply welding or heat to the clamp or its accessories. ● Do not use any other parts than our company's genuine parts. ● Clamps which require the repair should be stored at a different place so that they are not used mistakenly. 	 <p>Prohibited</p>
<ul style="list-style-type: none"> ● Persons with specialized knowledge designated by the business owner are to conduct maintenance and repairing work. ● When any abnormality with the clamp is found, do not use it and immediately repair or dispose. ● Remove, if any, paint or mud sticking to the moving parts of the clamp, cams, and pads. 	 <p>Instructed</p>

 **CAUTION**

<ul style="list-style-type: none"> ● Conduct maintenance and repairing without any load attached. ● Conduct maintenance and repairing after posting a sign indicating that you're on the maintenance work. ● Never fail to lubricate oil on the rotating parts of the clamp (around the pins), guide grooves, sliding parts, etc. ● Be sure to store clamps indoor. 	 <p>Instructed</p>
---	--

■ General warning for use (common to all lifting clamp models)

1. Be sure to select proper model clamps for use.
Pay special attentions to keep the lifting direction (rope angle).
2. Confirm the weight of the load. Do not exceed maximum capacity (designated ton) on clamps. (Never overload.)
3. Before use, confirm followings:
 - (a) Proper capacity of clamps.
 - (b) No abnormal movements of clamp or loosening of any bolts.
 - (c) No oil or other foreign matters on the surface of the cam and pad.
4. **Never use for load beyond the clamp range.**
5. When installing clamps, insert a lifting load completely until it comes in contact with the deepest of the jaw opening of main body.
6. **Depending on the model or capacity of the clamp, the cam teeth may not bite a load sufficiently when the load is a hard or light weight material (Less than 1/5 of maximum capacity or less than 1/4 of maximum clamp range). Confirm the condition of clamp for safety.**
7. Confirm that the safety lock is completely engaged in case clamp has a built-in lock.
8. Confirm that the load is well balanced. Determine the clamp position or the center of gravity of the rope properly. It is especially important to determine the horizontal center of gravity.
9. When lifting at 2 points, be sure to use two wire ropes, and make them equal length. (Fig. A)

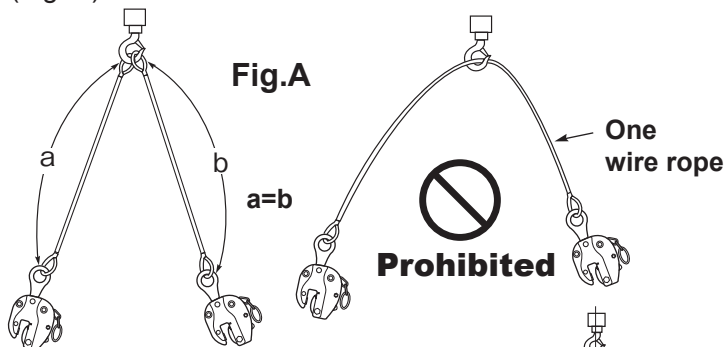

10. When lifting at 2 points, keep the lifting angle within 60°. (Fig. B)

(Follow the standards if lifting angle is specified depending on items.) If the load is long, use a balance.

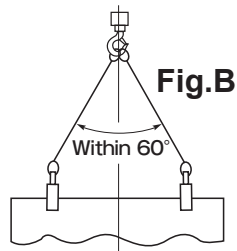

11. Never lift two or more steel plates or steel members at a time.
12. The load may move to an unexpected direction when lifted off the ground and as such confirm the center of gravity and the clamping position for safety when raising. Sufficient caution should be taken until the clamp with the load becomes completely balanced.
13. When changing directions of the load or any similar operations, all personnel must be clear of the area of operation. (Fig. C)

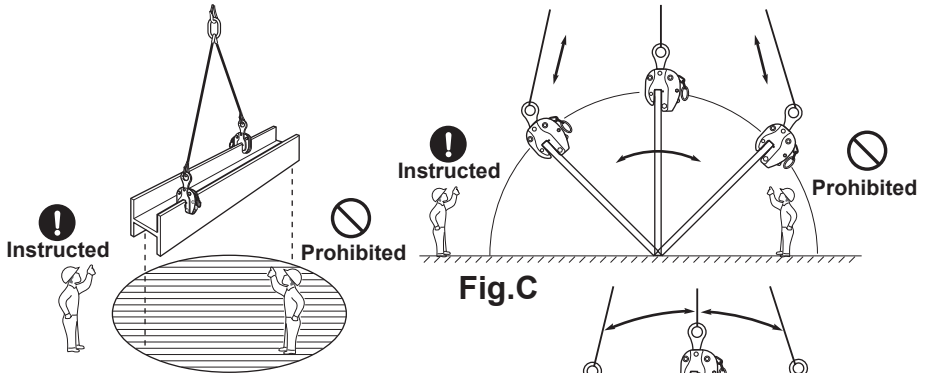

14. Do not ride on the lifting load.
Never use clamp for riding or carrying person.
15. Keep momentary inverting angle of a steel plate within 30°. (Fig. D)

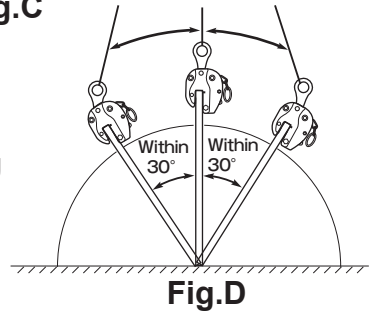

16. **Before operation, the surface of load must always be clean and free of scale, coatings or other foreign matters that will reduce clamping force significantly.**
17. **When raising, special attention must be given to prevent the rope from loosening by its unintended contact with any other objects.**
18. When raising again after the load is put on ground, reconfirm the clamp condition.
19. Do not use clamp for heated load or in a corrosion liquid because safety factor and durability will be reduced in such conditions.
20. Do not alter clamp by welding, cutting by gas or by any other modification.
21. Do not weld electrically a load while being lifted by clamp.
22. Conduct daily maintenance and lubrication.

■ Maintenance and Inspection

1. Maintenance

Daily maintenance is important for efficient and safe operation even under the severe use condition and for such purposes, please comply with the followings.

- (1) Designate the use standards and control.
- (2) Keep clamps indoor and do not leave them outdoor.
- (3) Check the followings to maintain in a good condition.
 - (a) Operating condition.
 - (b) Any abrasion, damage, or clogging at teeth of cam and pad.
 - (c) Deformation of main body - at jaw opening in particular.
- (4) Separate conforming clamps and other hazardous items identified during use or inspection and designate the defective sections. Perform maintenance any soon.
- (5) For the storage, place soft material as wooden chip in-between cam and pad to protect the teeth.
- (6) Perform inspection and maintenance once a week by referring to "Inspection Standards". Lubricate sliding sections periodically. (However, remove oil at teeth of cam and pad.)

2. Periodic Inspection

Perform periodic inspection in accordance with the periodic inspection and maintenance standards. Functions and life of clamps may differ in a great degree as they are used in varieties of fields under different conditions of use. Therefore, preparation and practice of effective handling/inspection standards manual by users themselves are recommended. We ask you to establish complete maintenance and control for assurance of safety in reference to our Manufacturer's Inspection Standards of our clamp. Clamp is designed for easy replacement of parts and therefore, do not fail to replace defective parts. Also, keeping spare parts at all times is recommended. For your preparation of the standards, pay special attention to the followings.

- (1) Operation and maintenance standards
 - (a) Preparation of use criteria (shape of load and operating methods).
 - (b) Thorough understanding and compliance of cautions on handling.
 - (c) Maintenance and storage.
 - (d) Rules of inspection and check at site.

- (2) Standards on periodic inspection
 - (A) Establishing dates of periodic inspection.
 - (B) Establishing inspection and maintenance methods.
 - (a) Inspecting period.
 - (b) Person in charge of the inspection.
 - (c) Inspection site.
 - (d) Tools and devices for inspection.
 - (e) Establishment of permissible limit of use.
 - (f) Explicit designation of maintenance and repair methods.

3. Manufacturer's inspection method

Our company's inspection procedures are as follow.

Check for

- (1) Movements.
- (2) Wear, loss, and/or clogging of/at the teeth of the cam and screw.
- (3) Deformation of main body.
- (4) Deformation of shackle.
- (5) The status of bolts, pins, links and springs.
- (6) Deep scratches in general.
- (7) Other checking items based on the Standards.

Lifting angle and rated load of wire rope

The maximum rated capacity of wire ropes also differs according to the lifting angle. Therefore, after paying attention to the lifting angle, always use wire ropes with the appropriate diameter.

Correlation table between the lifting angle and the applicable load for wire rope (for 2-point lifting)

■ JIS G 3525 6×24 A type

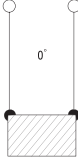
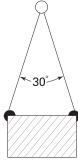
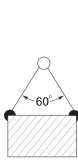
D wire rope diameter (mm)	W rated load (for 1 single rope) [Safety factor S=6] (ton)	  		
		(Change in % of the lifting capacity rate according to the lifting angle)		
		100%	96%	86%
Maximum allowable load (rated load) for 2 wire ropes (ton)				
6	0.30	0.60	0.57	0.51
8	0.53	1.07	1.03	0.92
9	0.67	1.35	1.30	1.16
10	0.83	1.67	1.61	1.44
12	1.20	2.41	2.32	2.08
14	1.64	3.28	3.15	2.83
16	2.14	4.28	4.12	3.69
18	2.72	5.44	5.23	4.69
20	3.35	6.70	6.44	5.77
22	4.06	8.12	7.81	7.00
24	4.82	9.65	9.28	8.32
26	5.66	11.3	10.8	9.76
28	6.58	13.1	12.6	11.3
30	7.55	15.1	14.5	13.0
32	8.58	17.1	16.5	14.8
36	10.8	21.7	20.8	18.7
40	13.4	26.8	25.8	23.1

Calculation formula of a wire rope diameter and rated load (for 1 single rope)

* Refer to the calculated values as rough indications.

① $D = \sqrt{W \times C}$

② $W = \frac{D^2}{C}$

D= wire rope dia. (mm)
W= rated load (ton)
C= 120 (constant)
(with Safety factor S = 6)

★ When looking for the required wire rope diameter to lift a 3 ton load

① $D = \sqrt{W \times C}$

$D = \sqrt{3 \times 120} = \sqrt{360} = 19 \rightarrow$

20mm

★ When looking for the maximum capacity (rated load) of a wire rope with 12mm diameter

② $W = \frac{D^2}{C}$

$W = \frac{12^2}{120} = \frac{144}{120} = 1.2 \rightarrow$

1.2ton



Vertical Lifting Clamp

(Lock Handle type with Universal shackle)

SVC-E

Operation Manual and Inspection Standards



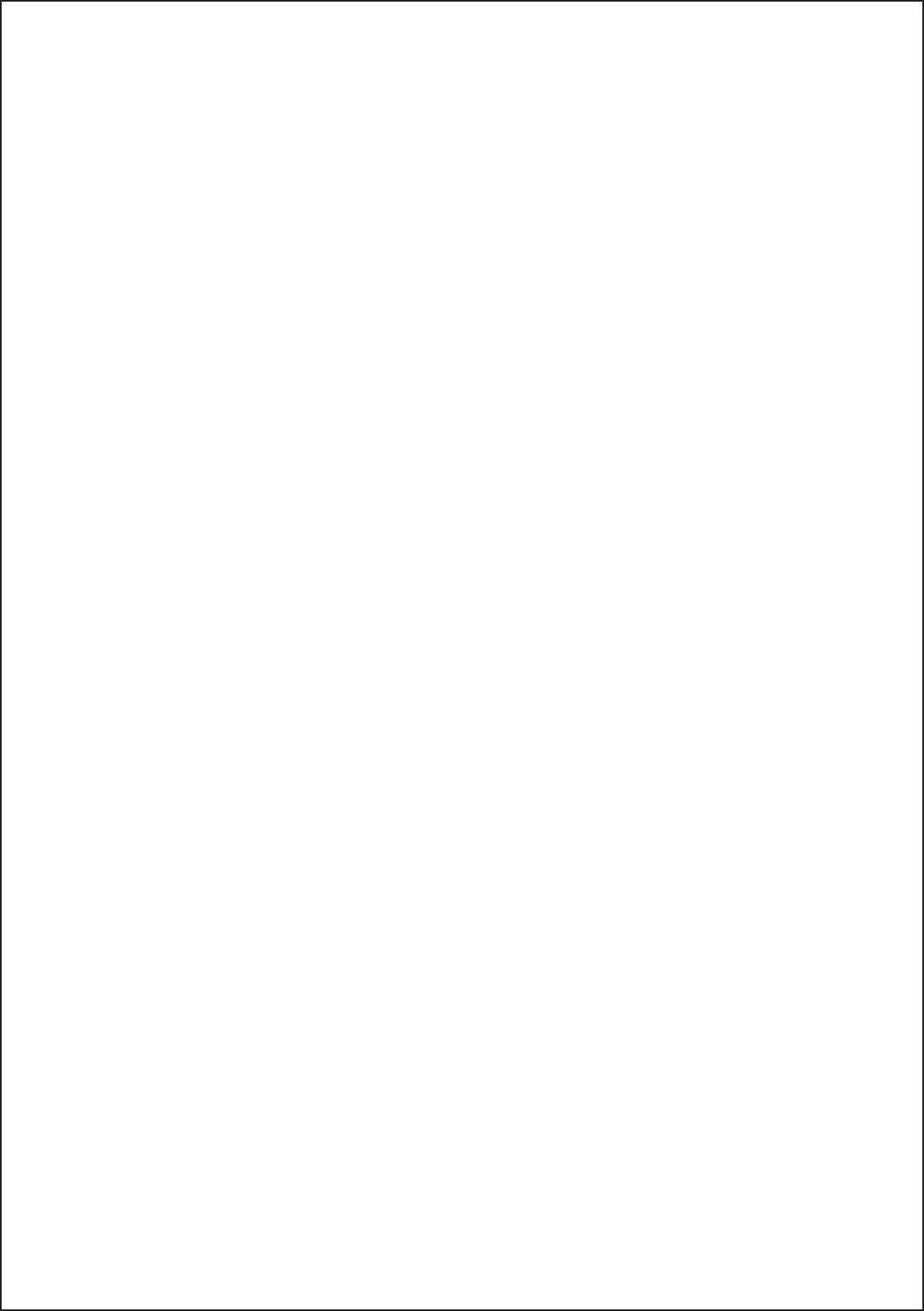

Vertical Lifting Clamp

(Lock Handle type
with Universal shackle)

SVC-E

■ Uses

Although this clamp is mainly designed for vertical lifting of steel plates, etc., it is a lightweight clamp that can also be conveniently used for inverting of shaped steel, etc., taking advantage of its structure.

■ Features

1. In proportion to the lifting load, the fastening force becomes larger and the circular cam clamps more firmly.
2. The shackle is a universal type and maintains a stable clamping condition.
3. Compact, lightweight, and easy to use.
4. Even after the load lands and the wire loosens, the circular cam does not come off, because the constant initial load always works by a spring.
5. The main parts are mold forged products of special alloy steel processed with optimal heat treatment, and thus strong and durable.

■ Specifications

Item No.	Rated Capacity (ton)	Clamp Range (mm)	New Weight (kg)
SVC0.3E	0.3	0~16	1.6
SVC0.5E	0.5	0~19	2.1
SVC1E	1	0~25	3.7
SVC1.5E	1.5	0~28	5.5
SVC2E	2	0~32	7.0

REPLACEMENT PARTS AND ASSEMBLIES

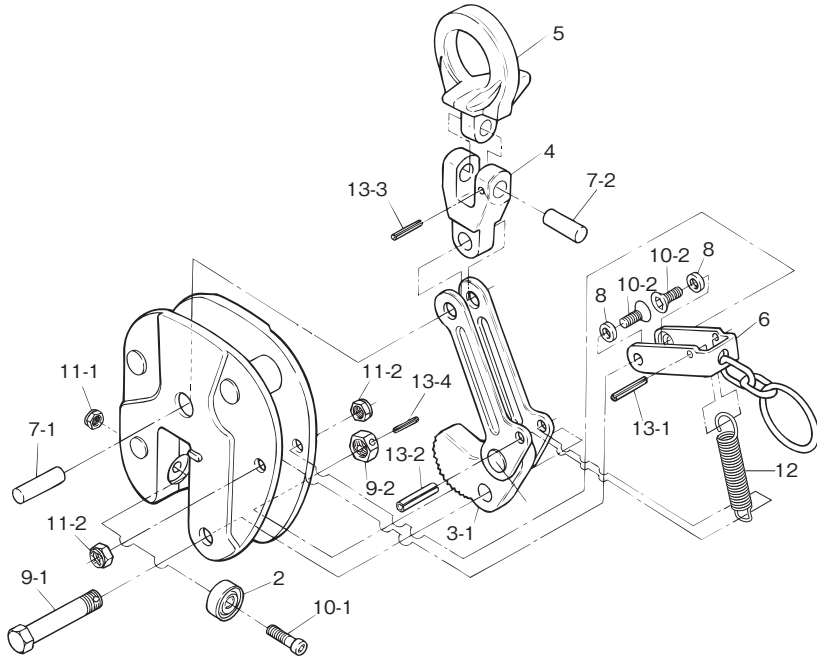

Part No.	Part Name	Item No.	Q'ty(pc)
Shackle Assembly		SVH	
4	Connector	SV CJ	1
5	Shackle	SV CH	1
7-1	Connecting Pin(long)	SV CY	1
7-2	Connecting Pin(short)	SV CX	1
13-3	Spring Pin	SV CR	1
Cam Assembly		SVT	
3-1	Cam (with link)	SV CT	1
13-2	Spring Pin	SV CU	1
Cam Support Pin Assembly		SVK	
9-1	Cam Support Bolt	SV CK	1
9-2	Cam Support Nut		1
13-4	Spring Pin	SV CO	1

Part No.	Part Name	Item No.	Q'ty(pc)
Pad Assembly		SVP	
2	Pad	SV CP	1
10-1	Bolt for Pad	SV CV	1
11-1	Nut for Pad		1
Lock Handle		SVG	
6	U-handle	SV CG	1
10-2	Hex. Head Disc Bolt	SV CF	2
11-2	U-nut		2
8	Collar	SV CZ	2
13-1	Spring Pin	SV CQ	1
12	Spring	SV CS	1

1)When ordering, specify the rated capacity (ton) of Item No. and E.

(For instance, Cam Assembly for SVC1E is SVT1E.)

2)Periodic lubrication is required at Pin and the sliding section.

(Remove oil from Pad and Cam teeth.)

■ How to use

1. OPERATION METHOD

- 1) Pull Lock Handle in the direction of arrow A in the figure below and push Shackle in the direction of the arrow to retract Cam into Main Body and release it.
- 2) When clamping, insert the load until the end of the load is no shallower than the reference line, and pull Lock Handle in the direction of arrow B to lock the load.

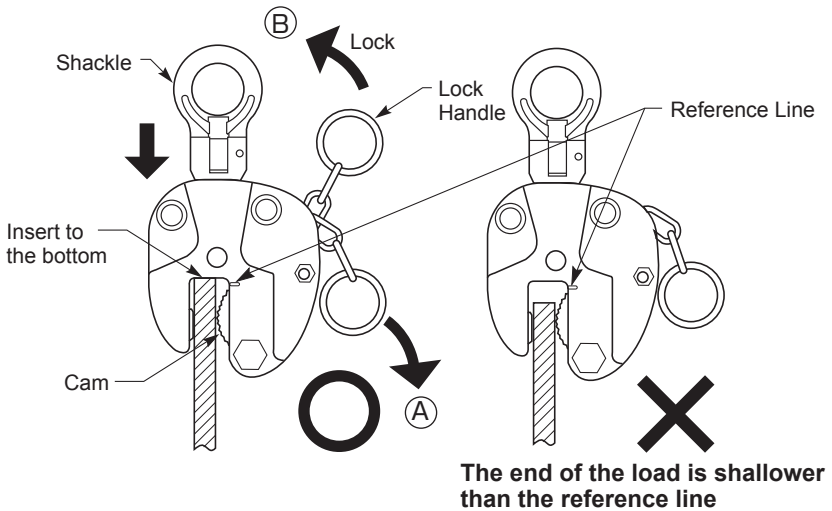

- 3) If the load is placed horizontally, insert the clamp with Pad facing down, then pull Lock Handle in the direction of the arrow in the figure on the right to lock the clamp.

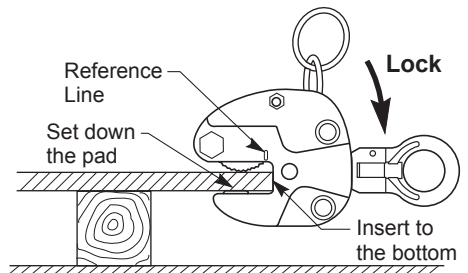

- 4) When detaching the load, follow the procedure 1).

2. OPERATION PATTERNS

① Keep the lifting angle as follows when lifting.

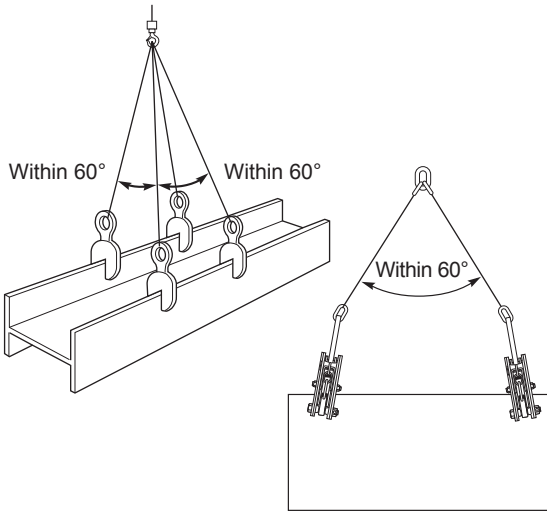

When lifting a pipe, make sure to position the cam inside to face each other and lift at 2 or more points. The minimum dia. of pipes for lifting is as per table below.

■ Minimum dia. pipes for vertical lifting

Capacity (ton)	0.3	0.5	1	1.5	2
Min. inside dia. of steel pipes (mm)	φ300	φ300	φ300	φ400	φ400

② Never clamp steel plate sideways like the picture on the right.
(The clamp might turn around and detach from the work to lift.)



③ Never lift more than one plate simultaneously.

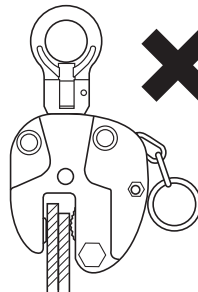

④ Never use the clamps like below. (The clamp might deform or break.)

A. Pulling out a plate from a stack. B. Pulling or bending of iron plate by using a press.

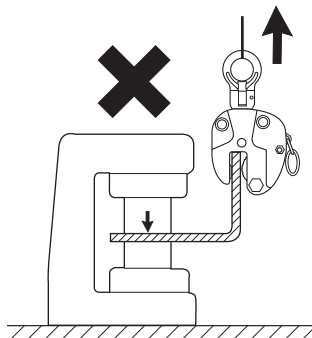
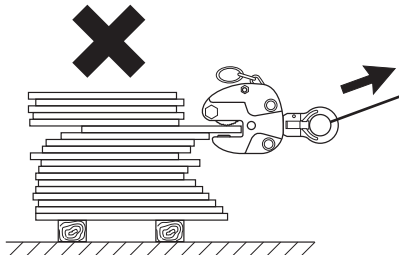

C. Pulling out sheet pile.

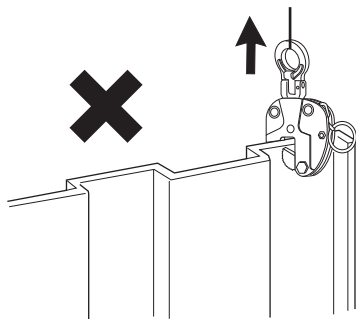

⑤ Other Handling Precautions

See P.2-10, P.17 for other handling instructions.

3. DISASSEMBLING AND ASSEMBLING

① Pad

A. Disassembling

After Cam is in the open lock state, insert a socket wrench that matches the nut into the rear part of Pad, insert a hexagon bar spanner into the bolt on the pad side, loosen the nut, and remove Pad.

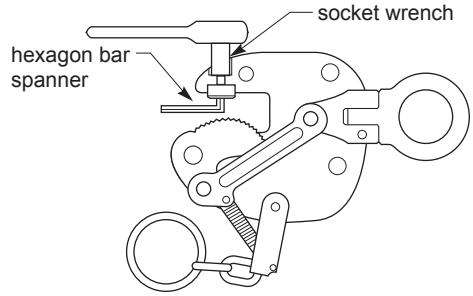

B. Assembling

Perform the reverse procedure of Disassembling.

② Cam and others

A. Disassembling

- 1) Remove Spring pin from Cam support nut, loosen Nut, and remove Cam support bolt.
- 2) Move Shackle, pull out Spring pin on the Connector, pull out Connecting Pin (short) and remove Shackle.
- 3) Push Connector into Main Body, align Connecting Pin (long) with the hole in the center of Main Body, and push Connecting Pin (long) out of the small hole on the back side of Main Body with a pin punch or similar tool to remove Connector and Cam.
- 4) Pull out Spring pin of Link that holds Spring and separate it from Spring.

Note that Cam and Link cannot be disassembled because they are set together with the link gasket pin.

B. Assembling

Perform the reverse procedure of Disassembling.

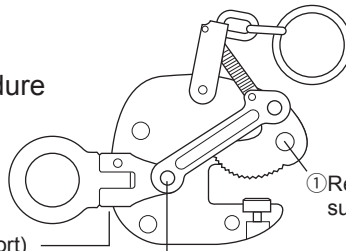

② Pull out Connecting Pin (Short) and remove Shackle.

③ Pull out Connecting Pin (long) to remove Connector and Cam.

■ CAUTION:

- ◆ Use within the rated capacity.
- ◆ Use within the clamp range.
- ◆ Do not use for any objects other than steel materials.
- ◆ Do not use for hard (30 HRC or higher) load.
- ◆ Lifting is not allowed for a load tapering down in upward direction.
- ◆ Do not apply shock to the load or lifting clamp.
- ◆ Do not lift more than one plate.
- ◆ Before using the product, be sure to check for clogging and wear of the teeth of the cam, screw and any other parts.
- ◆ Do not alter. Heating, modifying, etc. will significantly reduce the quality (strength).

■ OTHER:

- ◆ Inquiries for Repair Parts and Repair.
If repair parts or repairs are required, stop using this clamp and contact your distributor.

■ DAILY INSPECTION:

Conduct daily checks and maintenance to prevent the loss of safety and efficiency.

1. Check that there are no cracks at the body, cam, or wire rope holes.
2. Check if the movement and lubrication condition of each part are good.
3. Check for wear, loss, or clogging of the teeth of the cam and screw.
4. Refer to other inspection standards.

INSPECTION STANDARD FOR SVC-E

Item	Inspection method	Limit of use	Remedy
Main Body	Visually check or use color dyes to find cracks. Measure the jaw opening. Measure to find wear or deformation of holes of Support bolts.	When found visually. When the difference of "A" and "B" exceeds 5%. (5mm or more against 100mm in depth.) When the diameter of any one part of circumference of any hole exceeds the respective size in the table below.	Discard
	Visually check or measure to find deformation or gutter.	When the difference of "A" and "B" exceeds 2mm.	
Lock Handle	Measure to find wear or deformation of holes of Bolts. Visually check to find deformation.	When the diameter of any one part of circumference of any hole exceeds the respective size in the table below. When the movement of U-handle is not smooth.	Replace
Shackle	Visually check or use color dyes to find cracks. Visually check or measure-wear or deformation of Shackle hole and Pin hole. Visually check or measure to find deformation.	When found visually. When the diameter of any one part of circumference of any hole exceeds the respective size in the table below. When found the deformation exceeds more than 5° from the center line of Main Body.	Replace

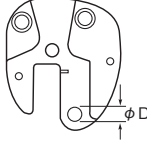
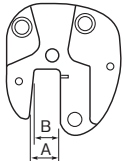

Rated Capacity (ton)	0.3	0.5	1	1.5	2
D (mm)	8.5	10.5	14.5	16.5	18.5

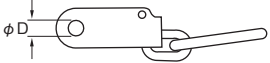
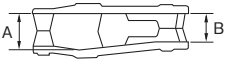

Rated Capacity (ton)	0.3	0.5	1	1.5	2
D (mm)	12.7	12.7	12.7	16.7	16.7

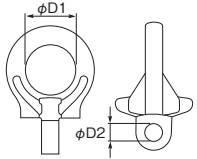

Rated Capacity (ton)	0.3	0.5	1	1.5	2
D1 (mm)	26.5	30.5	35.5	45.5	55.5
D2 (mm)	7.5	9.5	12.5	14.5	16.5

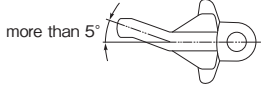

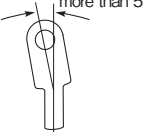
Item	Inspection method	Limit of use	Remedy												
Connector	Visually check or use color dyes to find cracks.	When found visually.	Replace												
	Measure to find wear or deformation of holes of Pins.	When the diameter of any one part of circumference of any hole exceeds the respective size in the table below. <table border="1" data-bbox="524 331 925 384"> <thead> <tr> <th>Rated Capacity (ton)</th> <th>0.3</th> <th>0.5</th> <th>1</th> <th>1.5</th> <th>2</th> </tr> </thead> <tbody> <tr> <td>D (mm)</td> <td>7.5</td> <td>9.5</td> <td>12.5</td> <td>14.5</td> <td>16.5</td> </tr> </tbody> </table>		Rated Capacity (ton)	0.3	0.5	1	1.5	2	D (mm)	7.5	9.5	12.5	14.5	16.5
	Rated Capacity (ton)	0.3		0.5	1	1.5	2								
D (mm)	7.5	9.5	12.5	14.5	16.5										
Measure to find wear or deformation of groove.	When the size of any one part of groove exceeds the respective size in the table below. <table border="1" data-bbox="524 475 860 528"> <thead> <tr> <th>Rated Capacity (ton)</th> <th>0.3</th> <th>0.5</th> <th>1</th> <th>1.5</th> <th>2</th> </tr> </thead> <tbody> <tr> <td>A (mm)</td> <td>10.5</td> <td>12.0</td> <td>13.5</td> <td>15.5</td> <td>16.5</td> </tr> </tbody> </table>	Rated Capacity (ton)	0.3	0.5	1	1.5	2	A (mm)	10.5	12.0	13.5	15.5	16.5		
Rated Capacity (ton)	0.3	0.5	1	1.5	2										
A (mm)	10.5	12.0	13.5	15.5	16.5										
Visually check or measure to find deformation.	When found the deformation exceeds more than 5° from the center line of Main body. 														
Cam Pad	Visually check and measure the degree of wear.	When the degree of wear exceeds 0.5mm.	Replace												
	Visually check or use color dyes to find cracks at the bottom cam teeth.	When found visually.													
	Visually check for broken teeth.	When any broken tooth is found.													
Measure wear or deformation of holes of Support Bolts.	When the diameter of any one part of circumference of any hole exceeds the respective size in the table below. <table border="1" data-bbox="524 1129 925 1182"> <thead> <tr> <th>Rated Capacity (ton)</th> <th>0.3</th> <th>0.5</th> <th>1</th> <th>1.5</th> <th>2</th> </tr> </thead> <tbody> <tr> <td>D (mm)</td> <td>8.5</td> <td>10.5</td> <td>14.5</td> <td>16.5</td> <td>19.5</td> </tr> </tbody> </table>	Rated Capacity (ton)	0.3	0.5	1	1.5	2	D (mm)	8.5	10.5	14.5	16.5	19.5		
Rated Capacity (ton)	0.3	0.5	1	1.5	2										
D (mm)	8.5	10.5	14.5	16.5	19.5										
Link	Visually check or measure to find deformation.	When extraordinary noise comes out or the movement is not smooth.	Replace												
	Measure wear or deformation of holes of Pins.	When the diameter of any one part of circumference of any hole exceeds the respective size in the table below. <table border="1" data-bbox="524 1401 925 1453"> <thead> <tr> <th>Rated Capacity (ton)</th> <th>0.3</th> <th>0.5</th> <th>1</th> <th>1.5</th> <th>2</th> </tr> </thead> <tbody> <tr> <td>D (mm)</td> <td>7.5</td> <td>9.5</td> <td>12.5</td> <td>14.5</td> <td>16.5</td> </tr> </tbody> </table>		Rated Capacity (ton)	0.3	0.5	1	1.5	2	D (mm)	7.5	9.5	12.5	14.5	16.5
Rated Capacity (ton)	0.3	0.5	1	1.5	2										
D (mm)	7.5	9.5	12.5	14.5	16.5										

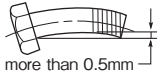
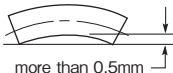
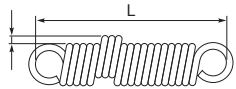
Item	Inspection method	Limit of use	Remedy												
Cam Support Bolt&Nut	Measure the frame part of Bolt for wear.	When the diameter of any one part of circumference of frame part exceeds the respective size in the table below. <table border="1"> <tr> <td>Rated Capacity (ton)</td> <td>0.3</td> <td>0.5</td> <td>1</td> <td>1.5</td> <td>2</td> </tr> <tr> <td>Diameter (mm)</td> <td>7.5</td> <td>9.5</td> <td>13.5</td> <td>15.5</td> <td>17.5</td> </tr> </table>	Rated Capacity (ton)	0.3	0.5	1	1.5	2	Diameter (mm)	7.5	9.5	13.5	15.5	17.5	Replace
	Rated Capacity (ton)	0.3	0.5	1	1.5	2									
Diameter (mm)	7.5	9.5	13.5	15.5	17.5										
Visually check or use color dyes to find cracks. Visually check or measure to find deformation.	When found visually. When deformation exceeds 0.5mm. 														
Connecting Pin (Long/Short)	Measure the frame part for wear.	When the diameter of any one part of circumference of frame part exceeds the respective size in the table below. <table border="1"> <tr> <td>Rated Capacity (ton)</td> <td>0.3</td> <td>0.5</td> <td>1</td> <td>1.5</td> <td>2</td> </tr> <tr> <td>Diameter (mm)</td> <td>6.5</td> <td>8.5</td> <td>11.5</td> <td>13.5</td> <td>15.5</td> </tr> </table>	Rated Capacity (ton)	0.3	0.5	1	1.5	2	Diameter (mm)	6.5	8.5	11.5	13.5	15.5	Replace
	Rated Capacity (ton)	0.3	0.5	1	1.5	2									
Diameter (mm)	6.5	8.5	11.5	13.5	15.5										
Visually check or measure to find deformation.	When deformation exceeds 0.5mm. 														
Spring	Visually check whether a constant initial load always works when Cam is closed. Visually check to find any cracks or deformations in the hooks at both ends. Visually check or measure to find deformation or extension.	When there is no normal repulsive force due to deformation, etc., or when the lock handle is set with the clamp dimension 0, and when a clearance is 1mm or more at the hooking area due to the dead weight of Shackle and Cam. When the inside diameter of the hook part is extremely worn or deformed and may come off from the spring pin. When the hook is deformed by more than 1mm or its total length exceeds the respective size in the table below. 	Replace												
		more than 1mm <table border="1"> <tr> <td>Rated Capacity (ton)</td> <td>0.3</td> <td>0.5</td> <td>1</td> <td>1.5</td> <td>2</td> </tr> <tr> <td>L (mm)</td> <td>44.0</td> <td>51.5</td> <td>67.0</td> <td>63.0</td> <td>71.0</td> </tr> </table>		Rated Capacity (ton)	0.3	0.5	1	1.5	2	L (mm)	44.0	51.5	67.0	63.0	71.0
Rated Capacity (ton)	0.3	0.5	1	1.5	2										
L (mm)	44.0	51.5	67.0	63.0	71.0										
Hex. Head Disc Bolt Collar Nut	Measure the frame part of Bolt for wear.	When the diameter of any one part of circumference of frame part exceeds the respective size in the table below. <table border="1"> <tr> <td>Rated Capacity (ton)</td> <td>0.3</td> <td>0.5</td> <td>1</td> <td>1.5</td> <td>2</td> </tr> <tr> <td>Diameter (mm)</td> <td>7.5</td> <td>7.5</td> <td>7.5</td> <td>9.5</td> <td>9.5</td> </tr> </table>	Rated Capacity (ton)	0.3	0.5	1	1.5	2	Diameter (mm)	7.5	7.5	7.5	9.5	9.5	Replace
	Rated Capacity (ton)	0.3	0.5	1	1.5	2									
Diameter (mm)	7.5	7.5	7.5	9.5	9.5										
Visually check to find deformation. Visually check if Nut is installed in good condition.	When the movement of U-handle is not smooth. When found damage, looseness, or disconnection.														

